



S.G.A.GOVERNMENT DEGREE COLLEGE

(Re-accredited by NAAC with 'A' Grade, Affiliated to Andhra University)

YELLAMANCHILI - 531055, ANDHRA PRADESH



DEPARTMENT OF ENGLISH

CIRCULAR

dated 21/03/2022

This is to inform the students of first year that the department of English is going to conduct a soft skills programme in English spoken English as well as employment skills. It includes telephone etiquette, interview skills, behavioural skill, interactive skills etc., Henceforth, with the instructions of the Principal of our college; the department of English is pleased to conduct the programme at zero hours of the college. Whoever interested in this programme, may consult the HOD of the department or Sri K.Premasagar to register their names.

G. SATYANARAYANA
HOD, Department of English
S.G.A. Govt. Degree College
Yellamanchilli, Visakhapatnam.

Principal
S.G.A. Govt. Degree College
Yellamanchilli-531 055
Anakapalli District. (A.P.)



S.G.A.GOVERNMENT DEGREE COLLEGE

(Re-accredited by NAAC with 'A' Grade, Affiliated to Andhra University)

YELLAMANCHILI - 531055, ANDHRA PRADESH



Teaching Interview skills and body language



S.G.A.GOVERNMENT DEGREE COLLEGE

(Re-accredited by NAAC with 'A' Grade, Affiliated to Andhra University)

YELLAMANCHILI - 531055, ANDHRA PRADESH



LIST OF STUDENTS ENROLLED

S.No.	Name of the Student	Hall ticket no.	Group
1	B.TEJESWINI	721135405082	I BSC
2	B.TEJOMAYEE	721135405083	I BSC
3	B.NAGA SHIVA GAYATHRI	721135405084	I BSC
4	B.SUKANYA	721135405085	I BSC
5	B.NOOKARATNAM	721135405086	I BSC
6	B.TEJASVI	721135405087	I BSC
7	B.LEELA PRAVEENA	721135405088	I BSC
8	B. DIVYA KRUPA	721135405089	I BSC
9	B.LAVANYA	721135405090	I BSC
10	CH.SWATHI	721135405091	I BSC
11	CH. MOKSHASRI	721135405092	I BSC
12	D.SIVAJI	721135405093	I BSC
13	D.NISSI ALEKHYA	721135405094	I BSC
14	E.HEMA VARAHA DURGA	721135405095	I BSC
15	G.EMMI VINOLINI	721135405096	I BSC
16	G.DHIKSHITHA	721135405097	I BSC
17	G.KIRANKUMAR	721135405098	I BSC
18	G.RANI	721135405099	I BSC
19	J.SINDHU	721135405100	I BSC
20	K. VASANTHA	721135405101	I BSC
21	K.LAKSHMI	721135405102	I BSC
22	K.LORIYA	721135405103	I BSC
23	K.MOUNIKA	721135405104	I BSC
24	K.KUMARI SREELAKSHMI	721135405105	I BSC
25	KDIVYA	721135405106	I BSC
26	L.YASAWINI	721135405107	I BSC
27	M.DEVI	721135405108	I BSC
28	M.NAGALAKSHMI	721135405109	I BSC
29	M.PUSHPALATHA	721135405110	I BSC
30	M.SRAVANI SAI	721135405111	I BSC
31	M. SIVA SRAVANI	721135405112	I BSC
32	M. NAVITHA	721135405113	I BSC
33	P.PAVANI	721135405114	I BSC
34	P.RATNA MALATHI NAVEENA	721135405115	I BSC
35	S.DIVYA	721135405116	I BSC
36	T.LOHITHA SRI	721135405117	I BSC
37	V.SAI	721135405118	I BSC
38	V.VINEEL	721135405119	I BSC
39	V.JAYASRI	721135405120	I BSC
40	V.TULASI	721135405121	I BSC



S.G.A.GOVERNMENT DEGREE COLLEGE

(Re-accredited by NAAC with 'A' Grade, Affiliated to Andhra University)

YELLAMANCHILI - 531055, ANDHRA PRADESH



Jawaharlal knowledge center

JKC Activities regarding Life skills

QUIZ Competitions





S.G.A.GOVERNMENT DEGREE COLLEGE

(Re-accredited by NAAC with 'A' Grade, Affiliated to Andhra University)

YELLAMANCHILI - 531055, ANDHRA PRADESH



Group Discussion





S.G.A.GOVERNMENT DEGREE COLLEGE

(Re-accredited by NAAC with 'A' Grade, Affiliated to Andhra University)

YELLAMANCHILI - 531055, ANDHRA PRADESH



Publicity Speaking





S.G.A.GOVERNMENT DEGREE COLLEGE

(Re-accredited by NAAC with 'A' Grade, Affiliated to Andhra University)

YELLAMANCHILI - 531055, ANDHRA PRADESH



**Our College Student P.Tulasi III B.Sc (MPC) got Prize Money in JNANABHERI competition conducted by the Government of Andhra Pradesh
Getting Memento from the Chief Minister of Andhra Pradesh N.Chandra Babu Naidu**



INNOVATIVE SKILLS

WORKING MODELS

S.NO	DATE	PROJECT NAME	GROUP	NUMBER OF STUDENTS INVOLVED
1.	28-10-2021	“Mind concentration game with moving ring”	MPCs	7
2.	09-11-2021	“Hydraulic traffic reducing system” and “conversion of solar energy into mechanical energy”	MPC	10
3.	23-11-2021	“Hydro electricity” and “Hydraulic lift “	MPCs	14
4.	06-12-2021	“Prevention of accidents in hilly areas” and “3D-hologram “	MPC	10
5.	10-12-2021	“Rain detector” and “hydraulic JCB”	MPCs	14

Lecturer in Physics
S.G.A GDC
YELLAMANCHILI

Principal
S.G.A Govt. Degree College
YELLAMANCHILI - 531 055
Vizakhapatnam District



S.G.A.GOVERNMENT DEGREE COLLEGE

(Re-accredited by NAAC with 'A' Grade, Affiliated to Andhra University)

YELLAMANCHILI - 531055, ANDHRA PRADESH



Student working model on “ MIND CONCENTRATION GAME WITH MOVING RING”prepared by Balaji team dated : 28-10-2021.

Lecturer in Physics
S.G.A. G.D.C.
YELLAMANCHILI

Principal
S.G.A. Govt. Degree College
YELLAMANCHILI - 531 055
Vizakhapatnam District



S.G.A.GOVERNMENT DEGREE COLLEGE

(Re-accredited by NAAC with 'A' Grade, Affiliated to Andhra University)

YELLAMANCHILI - 531055, ANDHRA PRADESH



Student working model on “HYDRALIC TRAFFIC REDUCING SYSTEM” AND “CONVERSION OF SOLAR ENERGY INTO MECHANICAL ENERGY” respectively prepared by Padma team and Gayathri team dated : 09-11-2021.

Lecturer in Physics
SGA GDC
YELLAMANCHILI

Principal
S.G.A Govt. Degree College
YELLAMANCHILI - 531 055
Vizakhapatnam District



S.G.A.GOVERNMENT DEGREE COLLEGE

(Re-accredited by NAAC with 'A' Grade, Affiliated to Andhra University)

YELLAMANCHILI - 531055, ANDHRA PRADESH



Student working model on **“HYDRO ELECTRICITY”** AND **“HYDRALIC LIFT”** respectively prepared by Ganesh Sri Saiteam and Naga Durga team dated : 23-11-2021.

Lecturer in Physics
SGA GDC
YELLAMANCHILI

Principal
S.G.A Govt. Degree College
YELLAMANCHILI - 531 055
Virekhatnam District



S.G.A.GOVERNMENT DEGREE COLLEGE

(Re-accredited by NAAC with 'A' Grade, Affiliated to Andhra University)

YELLAMANCHILI - 531055, ANDHRA PRADESH



Student working model on "**PREVENTION OF ACCIDENTS IN HILLY AREAS**" AND "**3D-HOLOGRAM**" Respectively prepared by Krishnaveni team and Uma Devi team

dated :06-12-2021.

Lecturer in Physics
S.G.A. GDC
YELLAMANCHILI

Principal
S.G.A. Govt. Degree College
YELLAMANCHILI - 531 055
Vizakhapatnam District



S.G.A.GOVERNMENT DEGREE COLLEGE

(Re-accredited by NAAC with 'A' Grade, Affiliated to Andhra University)

YELLAMANCHILI - 531055, ANDHRA PRADESH



Student working models on **“RAIN DETECTOR” AND “HYDRALIC JCB”** Respectively are prepared by Lakshmi team and Leela Lakshmi team dated : 10-12-2021.

Lecturer in Physics
SGA GDC
YELLAMANCHILI

Principal
S.G.A Govt. Degree College
YELLAMANCHILI - 531 055
Vizakhapatnam District



S.G.A.GOVERNMENT DEGREE COLLEGE

(Re-accredited by NAAC with 'A' Grade, Affiliated to Andhra University)

YELLAMANCHILI - 531055, ANDHRA PRADESH



Project Name

Water Overflow Alarm Indicator



Project Guided by Project done by Sri P.S.Jaggarao 1. M. Varma (II-B.Sc- MPCs)

HOD Department of Physics. 2. M. Sandeep (II-B.Sc- MPCs)

Sri K .

Venkanna 3. D. Prasad (II-B.Sc- MPCs) Lecturer in Physics



Water Overflow Alarm Indicator

Aim: Setting up of water level alarm indicator in our college campus at two places to minimize wastage of water and power

Introduction

We the group of three members are engaged to do Water Level over flow Indicator by Department of Physics. We have implemented this at two overhead water tanks in our college campus. Nowadays everybody has overhead tank at their homes. But everyone who has a water tank top of their homes knows the kind of problems that they face. Initially there is no system to track the water in the tank. Second problem is that when their water pump is started they have no idea when it gets filled up. Sometimes there are situations where the pump keeps on *pumping water to the tank* and the water starts *spilling out from the tank*. There is **wastage of energy** as well as **wastage of water**.

Components Required:

Buzzer, wire, nails...

Working

Now as the water starts to rise the sensors start to get in contact with the water and the transistors are activated and there is a flow of current in the transistors making the LED's light up. Here in between the transistor and the LED there is a current limiting resistor 470 ohms, the job of the resistor is to check that the LED does not get over voltage and destroy the LED. The transistor is biased by a 470K resistor with the ground and the sensing part is taken from the collector with a 33 ohms resistor going directly to the tank.

The Buzzer Part

Here you can add any of the normal buzzers that are readily available in the market and if it is not then you can make yourself with a simple 555 IC. We are giving a small circuit diagram, it is really simple to make it with a minimum components. It is a simple audio oscillator. We have also provided a circuit diagram.

The Power Supply

This section contains a transformer converting the mains voltage 220V brings down to 9V. There is a bridge rectifier containing 4 diodes and making the Alternating current to Direct Current. After the filtering the voltage is then directly fed to the voltage regulator (7805) with a filtering capacitor. From the regulator IC the output voltage is then again filtered with a capacitor and is fed to the circuit. This comprises the power supply of the device.

Outcomes

We minimized the water wastage and power wastage in our campus

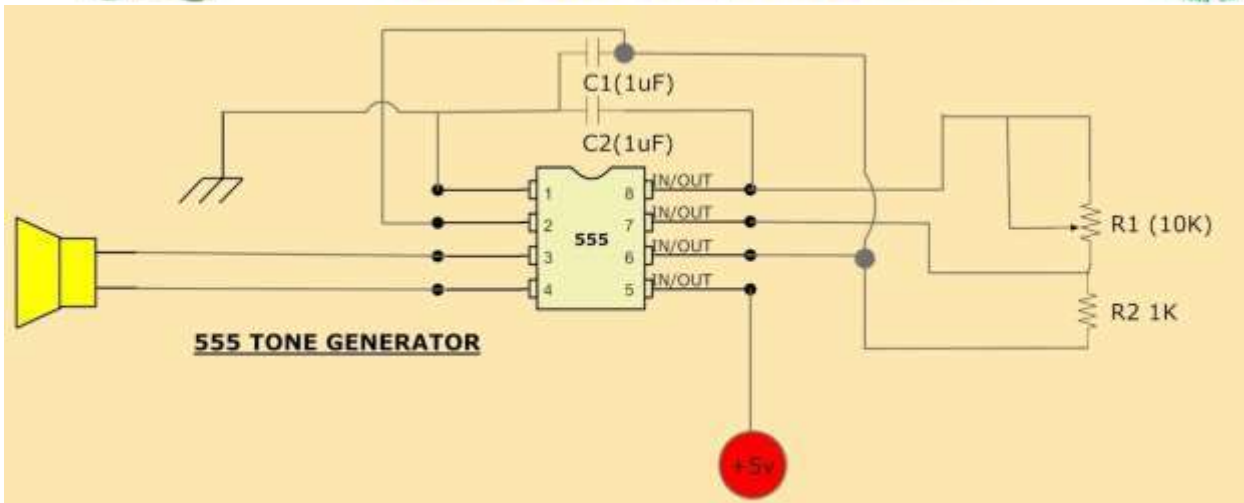

Above two figures shows circuit diagram of Buzzer indicator and tanks for which our project is implemented.



S.G.A.GOVERNMENT DEGREE COLLEGE

(Re-accredited by NAAC with 'A' Grade, Affiliated to Andhra University)

YELLAMANCHILI - 531055, ANDHRA PRADESH



Project implemented at overhead tanks located at top of principal chamber and top of seminar hall by our team members.



S.G.A.GOVERNMENT DEGREE COLLEGE

(Re-accredited by NAAC with 'A' Grade, Affiliated to Andhra University)

YELLAMANCHILI - 531055, ANDHRA PRADESH





S.G.A.GOVERNMENT DEGREE COLLEGE

(Re-accredited by NAAC with 'A' Grade, Affiliated to Andhra University)

YELLAMANCHILI - 531055, ANDHRA PRADESH



Group Discussion





S.G.A.GOVERNMENT DEGREE COLLEGE

(Re-accredited by NAAC with 'A' Grade, Affiliated to Andhra University)

YELLAMANCHILI - 531055, ANDHRA PRADESH



JAM(JustaMinute)Session





S.G.A.GOVERNMENT DEGREE COLLEGE

(Re-accredited by NAAC with 'A' Grade, Affiliated to Andhra University)

YELLAMANCHILI - 531055, ANDHRA PRADESH



Seminars





S.G.A.GOVERNMENT DEGREE COLLEGE

(Re-accredited by NAAC with 'A' Grade, Affiliated to Andhra University)

YELLAMANCHILI - 531055, ANDHRA PRADESH



Classes by the Students





S.G.A.GOVERNMENT DEGREE COLLEGE

(Re-accredited by NAAC with 'A' Grade, Affiliated to Andhra University)

YELLAMANCHILI - 531055, ANDHRA PRADESH



NewspaperReading





S.G.A.GOVERNMENT DEGREE COLLEGE

(Re-accredited by NAAC with 'A' Grade, Affiliated to Andhra University)

YELLAMANCHILI - 531055, ANDHRA PRADESH



Story Telling





S.G.A.GOVERNMENT DEGREE COLLEGE

(Re-accredited by NAAC with 'A' Grade, Affiliated to Andhra University)

YELLAMANCHILI - 531055, ANDHRA PRADESH



GuestLectures





S.G.A.GOVERNMENT DEGREE COLLEGE

(Re-accredited by NAAC with 'A' Grade, Affiliated to Andhra University)

YELLAMANCHILI - 531055, ANDHRA PRADESH



ONE DAY TRAINING ON ICT SKILLS TO NON-TEACHINGSTAFF

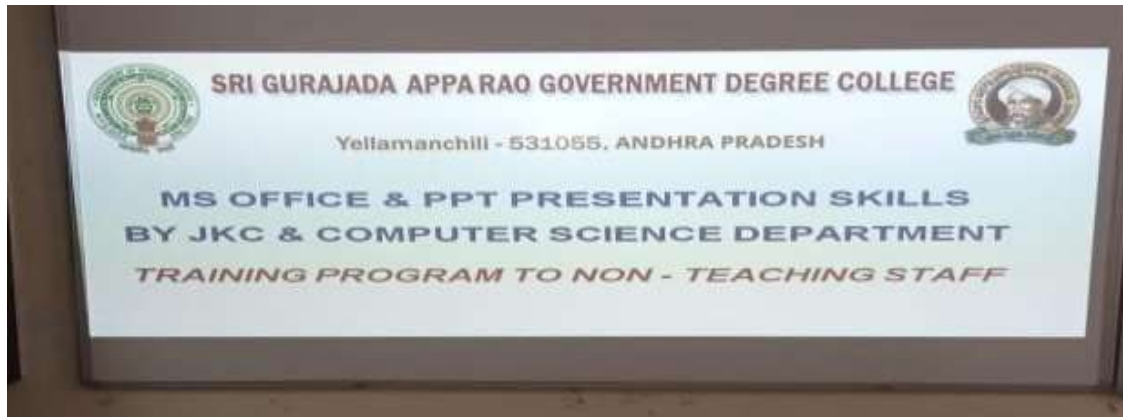

One Day Training on ICT skills to Non-Teaching Staff by JKC and Department of Computer Science Dated 18-10-2021.



S.G.A.GOVERNMENT DEGREE COLLEGE

(Re-accredited by NAAC with 'A' Grade, Affiliated to Andhra University)

YELLAMANCHILI - 531055, ANDHRA PRADESH



Teaching Interview skills and body language





S.G.A.GOVERNMENT DEGREE COLLEGE

(Re-accredited by NAAC with 'A' Grade, Affiliated to Andhra University)

YELLAMANCHILI - 531055, ANDHRA PRADESH



Circular

Date: 21-06-2017

This is to inform you that all the students as well all the teaching staff that our college is going to celebrate National Yoga Day on the eve of International Yoga Day, a call given by our beloved Prime Minister Narendra Modiji on 21st June at our Seminar Hall at 10:30 AM. You all are requested to attend with white uniform or any convenient dress and if possible please bring a yoga mat to perform yoga asanas and other related kriyas.

Your presence is highly demanded on this occasion as the class work suspended.

All the staff once again requested to make it a grand success. Together we can make it grand.

Signature of the CO-Ordinator,
Yoga and Physical fitness

Principal
S.G.A. Govt. Degree College
YELLAMANCHILI - 531055
Visakhapatnam District.



S.G.A.GOVERNMENT DEGREE COLLEGE

(Re-accredited by NAAC with 'A' Grade, Affiliated to Andhra University)

YELLAMANCHILI - 531055, ANDHRA PRADESH



Program: International Yoga Day

Date: 21-06-2017



Staff and students were participated in InternationalYoga day was conducted on 21-06-2017. Nearly 120 students were enrolled in this programme and all the enrolled students were actively participated and all the staff have also participated in this programme.



S.G.A.GOVERNMENT DEGREE COLLEGE

(Re-accredited by NAAC with 'A' Grade, Affiliated to Andhra University)

YELLAMANCHILI - 531055, ANDHRA PRADESH



STUDENTS ENROLLED AND PARTICIPATED IN YOGA AND MEDITATION 2017-18



S.G.A.GOVERNMENT DEGREE COLLEGE

(Re-accredited by NAAC with 'A' Grade, Affiliated to Andhra University)

YELLAMANCHILI - 531055, ANDHRA PRADESH



STUDENTS ENROLLED AND PARTICIPATED IN YOGA AND MEDITATION 2017-18

R. No	Name of the Student	Group	Signature of the student
	T.Devi	III B.A.	T. Devi
2	P.Purnachandra Rao	III B.A.	P. Purnachandra Rao
3	P.Syamala	III B.A.	P. Syamala
4	P.Bala Sai	III B.A.	P. Bala Sai
5	R.Upriya	III B.A.	R. Upriya
6	S.Sonia Rani	III B.A.	S. Sonia Rani
7	S.Yamini	III B.A.	S. Yamini
8	S.Jyothi	III B.A.	S. Jyothi
9	S.Bharahi	III B.A.	S. Bharahi
10	T.Rajesh	III B.A.	T. Rajesh
11	V.Ramanamma	III B.A.	V. Ramanamma
12	V.Parvathi	III B.A.	V. Parvathi
13	A.Vijaya	III B.A.	A. Vijaya
14	E.Ganga Bavani	III B.A.	E. Ganga Bavani
15	K.Hymamani	III B.A.	K. Hymamani
16	K.Lakshmi	III B.A.	K. Lakshmi
18	K.Satya Rao	III B.A.	K. Satya Rao
19	K.Appalanarasa	III B.A.	K. Appalanarasa
20	K.Anil Rajesh	III B.A.	K. Anil Rajesh
21	K.Mahalakshmi	III B.A.	K. Mahalakshmi
22	K.Nagamani	III B.A.	K. Nagamani
23	N.Lakshmi	III B.A.	N. Lakshmi
24	G.N.S Sathyanarayana	III B.Com	G.N.S Sathyanarayana
25	R.Venkata Lakshmi	III B.Com	R. Venkata Lakshmi
26	A.A.L.Poornima	III B.Com	A.A.L. Poornima
27	A.Sivaji	III B.Com	A. Sivaji
28	B.Nagendra Babu	III B.Com	B. Nagendra Babu
29	B.S.Bhavani	III B.Com	B. S. Bhavani
30	B.Ravikranth	III B.Com	B. Ravikranth
31	Ch.Apparao	III B.Com	Ch. Apparao
32	Ch.Raju	III B.Com	Ch. Raju
33	Ch.Prasad	III B.Com	Ch. Prasad
34	Ch.Tattayyalu	III B.Com	Ch. Tattayyalu
35	D.Gangadhar	III B.Com	D. Gangadhar
36	D.Naga Appala Raju	III B.Com	D. Naga Appala Raju
37	G.Siva	III B.Com	G. Siva
38	G.Saritha	III B.Com	G. Saritha
39	G.Maringa	III B.Com	G. Maringa
40	G.N.Venkatalakshmi	III B.Com	G.N. Venkatalakshmi
41	I. Sridevi	III B.Com	I. Sridevi
42	J.V.B.Kumar	III B.Com	J.V.B. Kumar
43	J.Gangadhar	III B.Com	J. Gangadhar
44	K.Naga Raju	III B.Com	K. Naga Raju
45	K.Nooka Raju	III B.Com	K. Nooka Raju
46	K.Arana	III B.Com	K. Arana
47	K.Durga Bhavani	III B.Com	K. Durga Bhavani



S.G.A.GOVERNMENT DEGREE COLLEGE

(Re-accredited by NAAC with 'A' Grade, Affiliated to Andhra University)

YELLAMANCHILI - 531055, ANDHRA PRADESH



S.G.A.GOVERNMENT DEGREE COLLEGE

(Re-accredited by NAAC with 'A' Grade, Affiliated to Andhra University)

YELLAMANCHILI - 531055, ANDHRA PRADESH



(17-18)

48	K.Rajesh	III B.Com	K. Rajesh
49	K.Bala Ganga	III B.Com	K. B. Ganga
50	K.Appala Raju	III B.Com	K. Appala Raju
51	K.Madhavi	III B.Com	K. Madhavi
52	A.Vamsi	III BSC	A. Vamsi
53	B.Pavani	III BSC	B. Pavani
54	B.Santhoshi	III BSC	B. Santhoshi
55	B.Venkata Lakshmi	III BSC	B. V. Lakshmi
56	B.Devi	III BSC	B. Devi
57	B.Sravani	III BSC	B. Sravani
58	C.Satya Chandini	III BSC	C. S. Chandini
59	D.Ganesh	III BSC	D. Ganesh
60	D.Gangadhar	III BSC	D. Gangadhar
61	D.Sanyaso Rao	III BSC	D. Sanyaso Rao
62	E.Gangadhara	III BSC	E. Gangadhara
63	G.Bhuvaneshwar Rao	III BSC	G. Bhuvaneshwar Rao
64	G.Anu	III BSC	G. Anu
65	G.Nirmala Kumara	III BSC	G. Nirmala Kumara
66	K.Swathi	III BSC	K. Swathi
67	K.Indravathi	III BSC	K. Indravathi
68	K.Venkatesh	III BSC	K. Venkatesh
69	L.Sunitha	III BSC	L. Sunitha
70	M.Srivani	III BSC	M. Srivani
71	M.U.Leela Kumara	III BSC	M. U. Leela Kumara
73	M.Sekharu	III BSC	M. Sekharu
74	M.Sowjanya	III BSC	M. Sowjanya
75	M.Akshaya Kumara	III BSC	M. Akshaya Kumara
76	P.Chantamma	III BSC	P. Chantamma
77	P.Prasad	III BSC	P. Prasad
78	R.Ramesh	III BSC	R. Ramesh
79	S.Govind Suresh	III BSC	S. Govind Suresh
80	S.Devi	III BSC	S. Devi
81	S.Gayathri	III BSC	S. Gayathri
82	Shaik Raziya Bhanu	III BSC	S. R. Bhanu
83	S.Bhooloka Naidu	III BSC	S. Bhooloka Naidu
84	T.Chandrakala	III BSC	T. Chandrakala



S.G.A.GOVERNMENT DEGREE COLLEGE

(Re-accredited by NAAC with 'A' Grade, Affiliated to Andhra University)

YELLAMANCHILI - 531055, ANDHRA PRADESH



S.G.A.GOVERNMENT DEGREE COLLEGE

(Re-accredited by NAAC with 'A' Grade, Affiliated to Andhra University)

YELLAMANCHILI - 531055, ANDHRA PRADESH



(17-18)

85	T.Bhavani	III BSC	T. bhavani
86	T.Nanaji	III BSC	T. nanaji
87	V.Sarojini	III BSC	V. sarajini
88	Y.Uma	III BSC	y. uma
89	A.Hindumathi	III BSC	A. Hindumathi
90	A.Durga Bhavani	III BSC	A. Durga Bhavani
91	A.Kavitha	III BSC	A. Kavitha
92	B.Jyothi	III BSC	B. Jyothi
93	B.Maha Lakshmi	III BSC	B. Maha Lakshmi
94	B.A.N.Murthy	III BSC	B. A. N. Murthy
95	B.Jyothi Ramya	III BSC	B. Jyothi Ramya
96	Ch.Amaravathi	III BSC	Ch. Amaravathi
97	G.Satya	III BSC	G. satya
98	G.Sri Lakshmi	III BSC	G. Sri Lakshmi
99	K.Kanchana	III BSC	K. Kanchana
100	K.Parvathi	III BSC	k. parvathi
101	K.Ganga Bhavani	III BSC	K. Ganga Bhavani
102	N.Uma Maheswari	III BSC	N. Uma Maheswari
103	N.Sireesha	III BSC	N. sireesha
104	O.Manikyam	III BSC	O. Manikyam
105	P.Uma	III BSC	p. uma
106	P.Kusuma Kumara	III BSC	P. Kusuma Kumara
107	P.Kiranmayi	III BSC	P. Kiranmayi
108	R.Nagalakshmi	III BSC	R. Nagalakshmi
109	S.Rama Devi	III BSC	S. Rama Devi
110	T.Nookaratnam	III BSC	T. Nookaratnam



S.G.A.GOVERNMENT DEGREE COLLEGE

(Re-accredited by NAAC with 'A' Grade, Affiliated to Andhra University)

YELLAMANCHILI - 531055, ANDHRA PRADESH



Circular

Date: 21-06-2018

This is to inform you that all the students as well all the teaching staff that our college is going to celebrate National Yoga Day on the eve of International Yoga Day, a call given by our beloved Prime Minister Narendra Modiji on 21st June at our Seminar Hall at 10:30 AM. You all are requested to attend with white uniform or any convenient dress and if possible please bring a yoga mat to perform yoga asanas and other related kriyas.

Your presence is highly demanded on this occasion as the class work suspended.

All the staff once again requested to make it a grand success. Together we can make it grand.

Signature of the CO-Ordinator,
Yoga and Meditation

Principal
S.G.A.Govt.Degree College
YELLAMANCHILI - 531055
Visakhapatnam District.



S.G.A.GOVERNMENT DEGREE COLLEGE

(Re-accredited by NAAC with 'A' Grade, Affiliated to Andhra University)

YELLAMANCHILI - 531055, ANDHRA PRADESH



Program: International Yoga Day Conducted on 21-06-2018



Staff and students participated in International

Yoga day on 21-06-2018



S.G.A.GOVERNMENT DEGREE COLLEGE

(Re-accredited by NAAC with 'A' Grade, Affiliated to Andhra University)

YELLAMANCHILI - 531055, ANDHRA PRADESH



LIST OF STUDENTS ENROLLED AND PARTICIPATED IN YOGA AND MEDITATION 2018-19



S.G.A.GOVERNMENT DEGREE COLLEGE

(Re-accredited by NAAC with 'A' Grade, Affiliated to Andhra University)

YELLAMANCHILI - 531055, ANDHRA PRADESH



LIST OF STUDENTS ENROLLED AND PARTICIPATED IN YOGA AND MEDITATION 2018-19

S. No	Name of the Student	Group	Signature of the student
1	K.Lokesh	III BA	K. Lokesh
2	P.Jaya Sri	III BA	P. Jaya Sri
3	N.Swathi	III BA	N. Swathi
4	Y.Jayalakshmi	III BA	Y. Jayalakshmi
5	Y.Bharathi	III BA	Y. Bharathi
6	CH.Sravni	III BA	CH. Sravani
7	K.Siva sankar	III BA	K. Siva Sankar
8	B.Radhika	III BA	B. Radhika
9	Y.Naga DURGA Prasad	III BA	Y. Naga Durga Prasad
10	S.Sandya Rani	III BA	S. Sandya Rani
11	A.Vasu	III BA	A. Vasu
12	K.Lakshmi Soujanya	III BA	K. Lakshmi Soujanya
13	V.Vasanta	III BA	V. Vasanta
14	K.Padmini	III BA	K. Padmini
15	M.Nooka Ratnam	III BA	M. Nooka Ratnam
16	M.Brajesh	III BA	M. Brajesh
18	G.Prasad	III BA	G. Prasad
19	p.Jyothi	III BA	P. Jyothi
20	B.Chandra Sekhar	III BA	B. Chandra Sekhar
21	S. Bhagya lakshmi	III BA	S. Bhagya Lakshmi
22	Ch.Nagalakshmi	III Bcom	CH. Nagalakshmi
23	Dhuli Charan Raja	III Bcom	D. Charan Raja
24	Dhuli Sravani	III B.Com	D. Sravani
25	E.Narasimha Murthy	III B.Com	E. Narasimha Murthy
26	Gangalla Ramu	III B.Com	G. Ramu
27	Gude Naga Sai Pushpa	III B.Com	G. Naga Sai Pushpa
28	Gutala Devi	III B.Com	Gutala Devi
29	Jarajana Devi	III B.Com	J. Devi
30	Jerryothula Bharathi	III B.Com	J. Bharathi
31	Jerryothula Durga Prasad	III B.Com	J. Durga Prasad
32	Kambula Bala Ganga	III B.Com	K. Bala Ganga
33	Kandrakota Raju	III B.Com	K. Raju
34	Kandrakota Veeralakshmi	III B.Com	K. Veeralakshmi
35	Konnuri Shesu Babu	III B.Com	K. Shesu Babu
36	Karri Indu	III B.Com	K. Indu
37	Karri Sai Thulasi	III B.Com	K. Sai Thulasi
38	Kasimkota Mahalakshmi	III B.Com	K. Mahalakshmi
39	Kottumuri Murali	III B.Com	K. Murali
40	Kolli Naga Kumar	III B.Com	K. Naga Kumar
41	Koppiji Sathyanarana	III B.Com	Koppiji Sathyanarana
42	K.Sathya Durga Prasad	III B.Com	K. Sathya Durga Prasad



S.G.A.GOVERNMENT DEGREE COLLEGE

(Re-accredited by NAAC with 'A' Grade, Affiliated to Andhra University)

YELLAMANCHILI - 531055, ANDHRA PRADESH



S.G.A.GOVERNMENT DEGREE COLLEGE

(Re-accredited by NAAC with 'A' Grade, Affiliated to Andhra University)

YELLAMANCHILI - 531055, ANDHRA PRADESH



(18)

43	Karandasu Kasu	III B.Com	.
44	Karupate Nagalakshmi	II Bcom	K. Negalekshmi
45	Laveti Krupa Rani	II Bcom	L. krupa Rani
46	Mandapati Manikyam	II Bcom	M. Manikyam
47	Mantini Jyothi	II Bcom	M. Jyothi
48	Mylapalli Rama Devi	II Bcom	M. Rama Devi
49	Nunna Kasi	II Bcom	N. Kasi
50	Pakurtti Nagaratnam	III BSC	P. Nagaratnam
51	Pinapala Hyma	III BSC	Pinapala Hyma
52	D.Rajya Lakshmi	III BSC	D. Rajya Lakshmi
53	D.Janaki	III BSC	D. Janaki
54	G.Sai durga Prasad	III BSC	G. Sai durga Prasad
55	G.Murali Krishna	III BSC	G. murali Krishna
56	G.Sylu Kumar	III BSC	G. Sylu Kumar
57	G.Gowri Parvathi	III BSC	G. Gowri parvathi
58	G.Naga Lakshmi	III BSC	G. Naga lakshmi
59	J.Ganesh	III BSC	J. Ganesh
60	J.Sukanya	III BSC	J. sukanya
61	J.Sivaji	III BSC	J. Sivaji
62	J.Varma	III BSC	J. varma
63	K.Bhavani	III BSC	K. Bhavani
64	K.Shirisha	III BSC	k. shirisha
65	K.R.N.Apparao	III BSC	K. R. U. Apparao
66	K.N.Apparao	III BSC	K. N. APPARAO
67	K.Ramya	III BSC	K. Ramya
68	K.Sai	III BSC	K. Sai
69	K.Rama Satya	III BSC	K. Rama Satya
70	K.Srinu	III BSC	K. Srinu
71	M.Srinu	III BSC	M. Srinu
73	M.Ramana	III BSC	M. Ramana
74	M.Srinu	III BSC	M. Srinu
75	P.N.Sai Kumar	III BSC	P. N. Sai Kumar
76	R.Sridhar	III BSC	R. Sridhar
77	R.Anil	III BSC	R. Anil
78	S.Asha	III BSC	S. Asha



S.G.A.GOVERNMENT DEGREE COLLEGE

(Re-accredited by NAAC with 'A' Grade, Affiliated to Andhra University)

YELLAMANCHILI - 531055, ANDHRA PRADESH



S.G.A.GOVERNMENT DEGREE COLLEGE

(Re-accredited by NAAC with 'A' Grade, Affiliated to Andhra University)

YELLAMANCHILI - 531055, ANDHRA PRADESH



(18-19)

79	S.Venkata Ramana	III BSC	S. Venkat Ramana
80	T.Geeta Satya	III BSC	T. Geeta Satya
81	V.Ganesh	III BSC	V. Ganesh
82	Y.Pydi Raju	III BSC	Y. Pydi Raju
83	Y.Naga Lakshmi	III BSC	Y. Naga Lakshmi
84	Y.Swathi Lakshmi	III BSC	Y. Swathi Lakshmi
85	A.Yamini	III BSC	A. Yamini
86	B.Nagaraju	III BSC	B. Nagaraju
87	B.Shirisha	III BSC	B. Shirisha
88	B.Hyma	III BSC	B. Hyma
89	B.V.Bhavani	III BSC	B.V. Bhavani
90	Ch.Naresh Kumar	III BSC	CH. Naresh Kumar
91	Ch.Durga Prasad	III BSC	CH. Durga Prasad
92	D.Nookaratnam	III BSC	D. NOOKARATHNAM
93	D.B.Ramadevi	III BSC	D.B. Ramadevi
94	G.Gowthami	III BSC	G. Gowthami
95	G.Vimala	III BSC	G. Vimala
96	G.Pournima	III BSC	G. Pournima
97	G.Durga Sravani	III BSC	G. Durga Sravani
98	J.Rani	III BSC	J. Rani
99	K.Akhila	III BSC	K. Akhila
100	K.Madhuri	III BSC	K. Madhuri



S.G.A.GOVERNMENT DEGREE COLLEGE

(Re-accredited by NAAC with 'A' Grade, Affiliated to Andhra University)

YELLAMANCHILI - 531055, ANDHRA PRADESH



Circular

Date: 21-06-2019

This is to inform you that all the students as well all the teaching staff that our college is going to celebrate National Yoga Day on the eve of International Yoga Day, a call given by our beloved Prime Minister Narendra Modiji on 21st June at our Seminar Hall at 10:30 AM. You all are requested to attend with white uniform or any convenient dress and if possible please bring a yoga mat to perform yoga asanas and other related kriyas.

Your presence is highly demanded on this occasion as the class work suspended.

All the staff once again requested to make it a grand success. Together we can make it grand.

Yoga and Physical Fitness

Principal
S.G.A.Govt.Degree College
YELLAMANCHILI - 531055
Visakhapatnam District.

ProgrammeCO-Ordinator,



S.G.A.GOVERNMENT DEGREE COLLEGE

(Re-accredited by NAAC with 'A' Grade, Affiliated to Andhra University)

YELLAMANCHILI - 531055, ANDHRA PRADESH



Program: International Yoga Day

Date: 21-06-2019



**Staff and students participated in International
Yoga day conducted on 21-06-2019**



S.G.A.GOVERNMENT DEGREE COLLEGE

(Re-accredited by NAAC with 'A' Grade, Affiliated to Andhra University)

YELLAMANCHILI - 531055, ANDHRA PRADESH



LIST OF STUDENTS ENROLLED AND PARTICIPATED IN YOGA AND MEDITATION 2019-20



S.G.A.GOVERNMENT DEGREE COLLEGE

(Re-accredited by NAAC with 'A' Grade, Affiliated to Andhra University)

YELLAMANCHILI - 531055, ANDHRA PRADESH



LIST OF STUDENTS ENROLLED AND PARTICIPATED IN YOGA AND MEDITATION 2019-20

S. No	Name of the Student	Group	Signature of the student
1	A.J.Durga Prasad	I B.A.	A. J. Durga Prasad
2	G.Lavanya	I B.A.	G. Lavanya
3	P.Sravani	I B.A.	P. Sravani
4	T.Lakshmi	I B.A.	T. Lakshmi
5	J.Ramu	I B.A.	J. Ramu
6	B.Bhanu Praksh	I B.A.	B. Bhanu praksh
7	G.Manasa	I B.A.	G. Manasa
8	M.Kamakshi Devi	I B.A.	M. Kamakshi Devi
9	G.Durga Prasad	I B.A.	G. Durga Prasad
10	M.Teja	I B.A.	M. Teja
11	L.Trinadh	I B.A.	L. Trinadh
12	P.Urmila	I B.A.	P. Urmila
13	G.Naveen	I B.A.	G. Naveen
14	D.Bharati	I B.A.	D. Bharathi
15	G.Naga Jyothi	I B.A.	G. Naga Jyothi
16	A.Sowjanya	I B.A.	A. Sowjanya
18	D.Durga Prasad	I B.A.	D. Durga Prasad
19	K.Lavanya	I B.A.	K. Lavanya
20	K.Indhumathi	I B.A.	K. Indhumathi
21	A.Konda Babu	I B.A.	A. Konda Babu
22	B.Gouri Devi	I B.A.	B. Gouri Devi
23	C.Harshavardhan	I B.A.	C. Harshavardhan
24	D.Av. V.S.N.Murthy	I B.A.	D. Av. V. S. N. Murthy
25	Korni Ammaji	III Bcom	Korni Ammaji
26	Mollu Vasantha	III Bcom	M. Vasantha
27	Mudi Kameswari	III Bcom	M. Kameswari
28	Muntha Diyva	III Bcom	M. Diyva
29	Murthy Ravi	III Bcom	M. Ravi
30	Mylapalli Prasad	III Bcom	M. Prasad
31	Nadupudi Vennela	III Bcom	N. Vennela
32	N.Koteswarao	III Bcom	N. Koteswarao
33	Penta Priyanka Rani	III Bcom	P. Priyanka Rani
34	Petkamsetti Shivani	III Bcom	P. Shivani
35	Pilla Ramya	III Bcom	P. Ramya
36	Pilla Jagadeesh	III Bcom	P. Jagadeesh
37	Polavarapu Lavanya	III Bcom	P. Lavanya
38	Potla Bharathi	III Bcom	P. Bharathi
39	Ramoji Jyothi	III Bcom	R. Jyothi
40	R.Gana Lakshmi	III Bcom	R. Gana Lakshmi
41	Ruthala Lavanya	III Bcom	R. Lavanya
42	Ruthala Lavanya	III Bcom	R. Lavanya
43	Sana Naga Devi	III Bcom	Sana Naga Devi



S.G.A.GOVERNMENT DEGREE COLLEGE

(Re-accredited by NAAC with 'A' Grade, Affiliated to Andhra University)

YELLAMANCHILI - 531055, ANDHRA PRADESH



S.G.A.GOVERNMENT DEGREE COLLEGE

(Re-accredited by NAAC with 'A' Grade, Affiliated to Andhra University)

YELLAMANCHILI - 531055, ANDHRA PRADESH



(19-20)

44	Somireddy Balamani	III Bcom	S. Balamani
45	Sundarapu Sathya	III Bcom	S. Sathya
46	Sunkara Lavanya	III Bcom	S. Lavanya
47	Tadepalli Leela Kumari	III Bcom	T. Leela Kumari
48	Vadhalapudi Bharathi	III Bcom	V. Bharathi
49	Varada Venkata Lakshmi Sravani	III Bcom	V. Venkata Lakshmi Sravani
50	Vegi Dhivya	III Bcom	Vegi Dhivya
51	Vunda Hari Babu	III Bcom	V. Hari Babu
52	Y. Bhagya Lakshmi	III Bcom	Y. Bhagya Lakshmi
53	A. Anuradha	III Bcom	A. Anuradha
54	B. Glori Stone	III Bcom	B. Glori Stone
55	Ch. Poorna Vigneswari	III Bcom	Ch. Poorna Vigneswari
56	D. Raja Kumari	III Bcom	D. Raja Kumari
57	E. Shivaji	III Bcom	E. Shivaji
58	G. Mukesh	III Bcom	G. Mukesh
59	G. Giri	III Bcom	G. Giri
60	I. Jagadesh	III Bcom	I. Jagadesh
61	K. Jyothi	III Bcom	K. Jyothi
62	K. Pavan Sai	III Bcom	K. Pavan Sai
63	K. Satya Veni	III Bcom	K. Venkatesh
64	K. Venkatesh	III Bcom	K. Venkatesh
65	K. Naga Lakshmi	III Bcom	K. Naga Lakshmi
66	L. Neerisha	III Bcom	L. Neerisha
67	M. Suryamani	III Bcom	M. Suryamani
68	M. Prasad	III Bcom	M. Prasad
69	M. Sai	III Bcom	M. Sai
70	N. Tulasi	III Bcom	N. Tulasi
71	N. Sai Lakshmi	III Bcom	N. Sai Lakshmi
73	O. Manga	III Bcom	O. Manga
74	O. Shivaji	III Bcom	O. Shivaji
75	P. Vara Lakshmi	III Bcom	P. Vara Lakshmi
76	P. Neeraja	III Bcom	P. Neeraja
77	P. Venkats Lakshmi	III Bcom	P. Venkats Lakshmi
78	P. Bangra Raju	III Bcom	P. Bangra Raju
79	P. Jagatha	III Bcom	P. Jagatha
80	G. Sai Durga Prasad	III BSC	G. Sai Durga Prasad
81	G. Murali Krishna	III BSC	G. Murali Krishna
82	G. Sylu Kumar	III BSC	G. Sylu Kumar
83	G. Gowri Parvathi	III BSC	G. Gowri Parvathi
84	G. Naga Lakshmi	III BSC	G. Naga Lakshmi
85	J. Ganesh	III BSC	J. Ganesh
86	J. Sukanya	III BSC	J. Sukanya
87	J. Sivaji	III BSC	J. Sivaji



S.G.A.GOVERNMENT DEGREE COLLEGE

(Re-accredited by NAAC with 'A' Grade, Affiliated to Andhra University)

VELLAMANCHILI - 531055, ANDHRA PRADESH



S.G.A.GOVERNMENT DEGREE COLLEGE

(Re-accredited by NAAC with 'A' Grade, Affiliated to Andhra University)

VELLAMANCHILI - 531055, ANDHRA PRADESH



(19-20)

88	J.Varma	III BSC	J-Varma.
89	K.Bhavani	III BSC	K.Bhavani
90	K.Shirisha	III BSC	k-shirisha,
91	K.R.N.Apparao	III BSC	k-R-N-Apparao -
92	K.N.Apparao	III BSC	K.N.Apparao
93	K.Ramya	III BSC	K.Ramya
94	K.Sai	III BSC	K.gai
95	K.Rama Satya	III BSC	K.Rama satya
96	K.Srinu	III BSC	K.Srinu-
97	M.Srinu	III BSC	M.Srinu.
98	M.Ramana	III BSC	M.Ramana
99	M.Srinu	III BSC	m.Sreenu.
100	P.N.Sai Kumar	III BSC	P.N.gai Kumar.



S.G.A. GOVERNMENT DEGREE COLLEGE

(Re-accredited by NAAC with 'A' Grade, Affiliated to Andhra University)

YELLAMANCHILI - 531055, ANDHRA PRADESH



Initiatives OF ENGLISH LANGUAGE LAB

About English Language & Lab

The English Language Lab was established in our college during the academic year . It was inaugurated on

India is following three language formulae as recommended by the Kothari Commission wide the National Education policy in 1968. In these three language formulae the national, international and regional interests were taken into consideration. The constitution of India recognized Hindi as national language, English as second language or third depending on the need and the state/regional language as third language. In Andhra Pradesh these three language formulae observed with the spirit of the constitution and in school and college education, up to degree, English language made as compulsory. As the importance of language grows in seeking for further education, employment opportunities, communication skills and soft skills the government of Andhra Pradesh introduced English Language Labs at degree level. The motto of these labs is to enhance English knowledge giving priority to the language skills, i.e., Listening, Speaking, Reading and Writing.

English language gained momentum after globalization, world trade and the revolutionary change in Information and communication technology which synchronized the world into a global village. The speed of communication in various modes like mass media, twitter, what's app, google mail, etc., came into use. The present direct or face-to-face education system replaced to some extent by blended learning which is less efforted in cost and time. On line education, evaluation and assessment made easy in this ICT. Because of this, the fear factor, shyness to rise a doubt and answer a question even though the stakeholder knew the answer will be addressed through language lab up to the attainment of confidence to face the above problems. The stakeholders will develop a self-consciousness about their mistakes and they themselves rectify as it is a self-faced learning. Another facility is. they can repeatedly use this lab for excellence unlike in the live class room. To reach global standards, up-dating their knowledge, it is essential to give such knowledge to the students through English Language Labs.

The word lab is usually associated with science and technology. So, how an English lab works and what is its practicality in learning or acquisition of language may arise some doubts in everyone's mind. Here is the answer. Any language is skill based. In any language the common skills are listening, speaking, reading and writing. In these skills two are active skills and two are passive skills. Listening and reading are passive and speaking and writing are active skills. In English language lab, the ability of hearing, using a headset will be tested. It also helps to know the conceptualization or understanding and grasping the content. Prompting, utterance, modulation, pitch, rising and falling tones could be possible through this lab. Through voice recorder the stakeholders could rectify their pronunciation errors.

Lab equipment:

The lab is equipped with 30 table top computers partitioned with glass compartments. Each computer has enough configuration to suit the needs of the students. Apart from hardware the software relating to other necessities equipped with. Head phones are provided. In software, communication skills CD's, spoken language CD's, dictionaries also provided. Good seating arrangements with a revolving chair are provided. Keyboard and mouses, monitors, CPU's, power cables with UPIs also provided. A public addressing system, overhead projector, 24 x 7 power supporting batteries for back-up service, books on English language and grammar are provided. Altogether a good ambience of learning English language was created in this English language lab.

Objectives of the lab:

- To provide good pronunciation skills
- To make the stakeholders fluent in spoken English
- To improve good communication
- To improve employment skills
- To improve various mailing systems like google mail, what's app, twitter etc.,



S.G.A. GOVERNMENT DEGREE COLLEGE

(Re-accredited by NAAC with 'A' Grade, Affiliated to Andhra University)

YELLAMANCHILI - 531055, ANDHRA PRADESH



- To develop personality skills
- To improve interview skills
- To improve net-etiquette skills
- To improve reading (a loud), and reciting skills
- To improve addressing, public speech, oratory skills
- To improve presentation skills
- To improve drafting skills
- To improve news writing, document writing, pleading, noticing, mongering skills.
- To improve good listening (Active listening) skills
- To improve writing skills.

Lab Activities

1. Dictation to every batch.
2. Spelling check
3. Pronunciation
4. Hearing test
5. Online grammar test
6. YouTube videos
7. Running commentary (while the video is playing)
8. Reading aloud (comprehension passages)
9. Recitation of poems
10. Phonetics
11. E-mail and Hot-mails
12. C.V's & cover letter practice
13. Monologues
14. Dialogues
15. One-act plays
16. Group & Team works
17. Role play
18. Information giving & taking techniques
19. Debates
20. Elocutions



S.G.A. GOVERNMENT DEGREE COLLEGE

(Re-accredited by NAAC with 'A' Grade, Affiliated to Andhra University)

YELLAMANCHILI - 531055, ANDHRA PRADESH



Our college English language lab

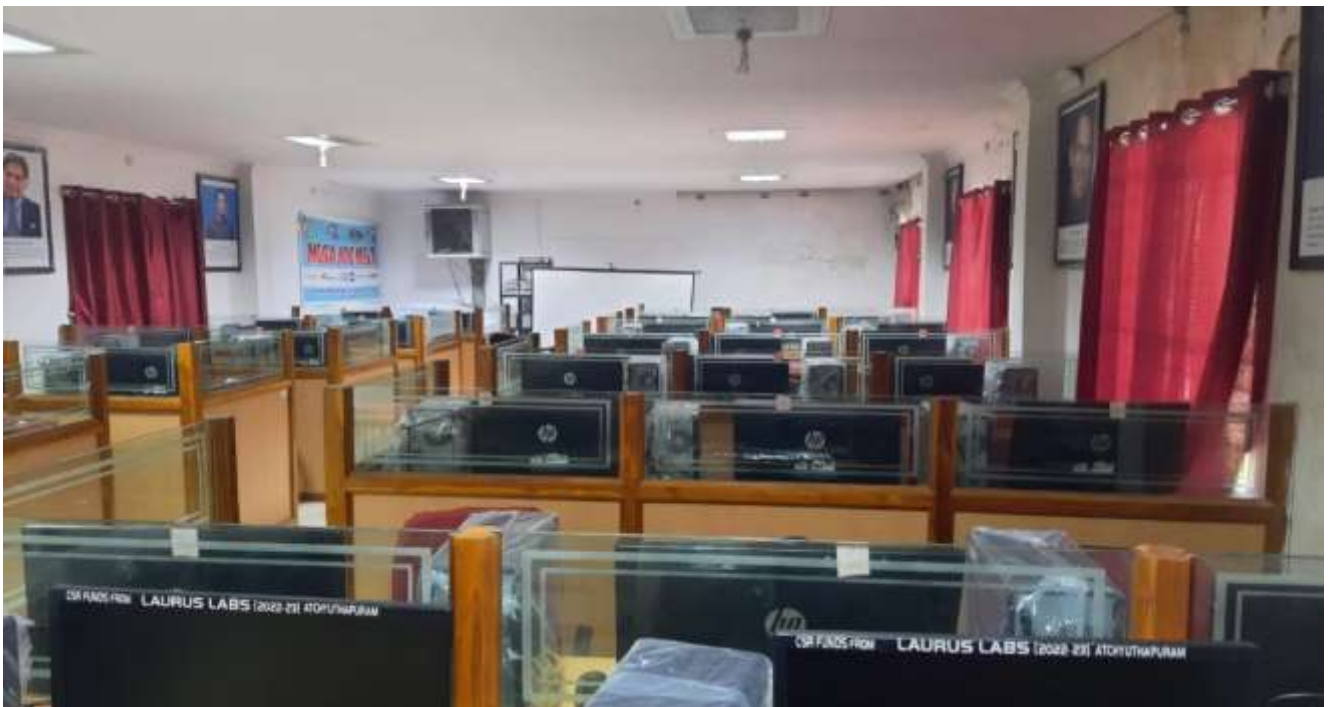



S.G.A. GOVERNMENT DEGREE COLLEGE

(Re-accredited by NAAC with 'A' Grade, Affiliated to Andhra University)

YELLAMANCHILI - 531055, ANDHRA PRADESH



Conducting hearing test to the students with the help of head phones





S.G.A. GOVERNMENT DEGREE COLLEGE

(Re-accredited by NAAC with 'A' Grade, Affiliated to Andhra University)

YELLAMANCHILI - 531055, ANDHRA PRADESH



LANGAUGE AND C COMMUNICATION SKILLS

Dated: 08/2/2022

To
The Principal,
S.G.A., Govt. Degree College,
Yelamanchili,
Anakapalli Dist.,

Respected Sir

Sub: Request –Permission—Communication skills and soft skills for a new batch—regarding

&&&

The department of English is pleased to inform you that we initiated a programme to improve students communication and soft skills for their individual development. For this the batches were selected from students and listed here with consisting of II B.A., and II B. Sc students. Please permit this batch to conduct classes in zero hours. This is for your kind information and record to take further action.

Thanking you Sir,

Yours sincerely

(G. SATYANARAYANA)



S.G.A. GOVERNMENT DEGREE COLLEGE

(Re-accredited by NAAC with 'A' Grade, Affiliated to Andhra University)

YELLAMANCHILI - 531055, ANDHRA PRADESH



DEPARTMENT OF ENGLISH

CIRCULAR

Dated: 9/02/2022

This is to inform the students of second year that the department of English is going to conduct a soft skills programme in English spoken English as well as employment skills. It includes telephone etiquette, interview skills, behavioural skill, interactive skills etc., Henceforth, with the instructions of the Principal of our college; the department of English is pleased to conduct the programme at zero hours of the college. Whoever interested in this programme, may consult the HOD of the department or Sri K. Premasagar to register their names



G.Satynarayana lecturer in English delivering his lecture on soft skills



S.G.A. GOVERNMENT DEGREE COLLEGE

(Re-accredited by NAAC with 'A' Grade, Affiliated to Andhra University)

YELLAMANCHILI - 531055, ANDHRA PRADESH



LIST OF STUDENTS ENROLLED

S.No.	Name of the Student	Hall ticket no.	Group
1	A.KONDA BABU	120135401001	II BA
2	B.GOURI DEVI	120135401002	II BA
3	C.HARSHAVARDHAN	120135401003	II BA
4	D.AV.V.S.N.MURTHY	120135401004	II BA
5	D.PAVAN KUMAR	12013540100	II BA
6	E.SARAWATHI	120135401007	II BA
7	K.SRINIVASA RAO	120135401008	II BA
8	K.MOHAN	190135401009	II BA
9	K.DURGA PRASAD	120135401011	II BA
10	K.APPALA RAJU	120135401013	II BA
11	P.MUNNA	120135401015	II BA
12	P.DURGA PRASAD	120135401016	II BA
13	R.VENKALAKSHMI	120135401017	II BA
14	R.GANESH	120135401018	II BA
15	ARJILLIAMMAJI	720135405071	II BSC
16	CHITTIDEVIKA	720135405072	II BSC
17	DEVARADIVYA	720135405073	II BSC
18	ERIGILAVANDANA	720135405074	II BSC
19	GORINTAMEENAKSHI	720135405075	II BSC
20	GUDDATIUSHARANI	720135405076	II BSC
21	KALLAPUSHPALAKSHMI	720135405077	II BSC
22	KANTAMREDDYASHA	720135405078	II BSC
23	KARRIVISWANADHAM	720135405079	II BSC
24	KOLANTIANUSHA	720135405080	II BSC
25	M.BHAGYALAKSHMI	720135405081	II BSC
26	MOGILIBHARGAVI	720135405082	II BSC
27	MOORARATNAKUMARI	720135405083	II BSC
28	OMMIKUMARI	720135405084	II BSC
29	PADALATRIVENI	720135405085	II BSC
30	PEDAPUDILATHA	720135405086	II BSC
31	PUDIKAHYA	720135405087	II BSC
32	RAJESWARIYANDA	720135405088	II BSC
33	RANGALANAVYA	720135405089	II BSC
34	REDDIDAIVAMADHURI	720135405090	II BSC
35	R.VENKATALAKSHMI	720135405091	II BSC
36	SHAIKRAHIMTUNEESEA	720135405092	II BSC
37	SONYGUDALA	720135405093	II BSC
38	TELUSURYALAKSHMI	720135405094	II BSC
39	TH. MOUNIKADEVI	720135405095	II BSC
40	AMALAKANTISATYA	720135405070	I BSC



S.G.A. GOVERNMENT DEGREE COLLEGE

(Re-accredited by NAAC with 'A' Grade, Affiliated to Andhra University)

YELLAMANCHILI - 531055, ANDHRA PRADESH



Testing and listening pronunciation of the students



S.G.A. GOVERNMENT DEGREE COLLEGE

(Re-accredited by NAAC with 'A' Grade, Affiliated to Andhra University)

YELLAMANCHILI - 531055, ANDHRA PRADESH



DEPARTMENT OF BOTANY

Student Seminars, 2017-22

S.No	Date	Name of the Student	Group	Name of the Topic
1	07-03-2018	B.Sireesha	II CBZ	Photophosphorylation
2	07-03-2018	P.Pushpa	II CBZ	Mechanism of Enzyme reaction
3	07-03-2018	R.NagaLakshmi	III CBZ	Methods of Sterilization
4	07-03-2018	O.Manikyam	III CBZ	Totipotency
5	20-08-2018	Y.Anoosha	II CBZ	Types of Endosperm
6	20-08-2018	G.Nagamani	II CBZ	Principles of Taxonomy
7	18-09-2018	R.Srinu	II CBZ	C3 and C4 Plants differences
8	19-09-2018	S.Raju	II CBZ	Endosperm types
9	03-08-2019	B.Gayathri	III CBZ	Structure of DNA
10	09-08-2019	Ch.SatyaSruvanthi	III CBZ	Importance of Temperature
11	09-08-2019	N.Jayasri	III CBZ	Importance of Light
12	20-08-2019	Ch.Gayathri	I CBZ	Structure of TMV Virus
13	20-08-2019	P.Bhavani	I CBZ	Marchantia characters
14	23-01-2020	G.Sandhya	I CBZ	Funaria Capsule
15	23-01-2020	K.Symala	I CBZ	Boerhavia Stem T.S
16	06-02-2020	B.Tulasi Naga Lakshmi	II CBZ	Macroelements
17	06-02-2020	P.SuryaKala	II CBZ	Mechanism of Enzyme reaction
18	06-02-2020	J. Jayasri	II CBZ	Ascent of Sap-Theories
19	22-02-2020	V.Kruparani	III CBZ	Principles of rDNA Technology
20	22-02-2020	N.Jayasri	III CBZ	Golden rice
21	22-02-2020	B.Gayathri	III CBZ	Principles of Plant Tissue culture
22	28-12-2020	R.Sunitha	III CBZ	Gloriosa superba
23	28-12-2020	N.Triveni	III CBZ	Rauwolfia serpentina



S.G.A. GOVERNMENT DEGREE COLLEGE

(Re-accredited by NAAC with 'A' Grade, Affiliated to Andhra University)

YELLAMANCHILI - 531055, ANDHRA PRADESH



24	11-02-2021	Ch.Gayathri	II CBZ	PolyembryonyandTypes
25	11-02-2021	K.UmaMaheswari	II CBZ	Asteraceae
26	11-02-2021	V.Varaparasad	II CBZ	MonosporicEmbryosac
27	11-02-2021	D.Dhamani	II CBZ	PlantKingdomClassificaation
28	11-02-2021	R.Lavanya	II CBZ	TypesofPollentubeEntrymethods
29	11-02-2021	G.Sandhya	II CBZ	Microsporogenesis
30	11-02-2021	P.Koti	III CBZ	StepsinvolvedinPlantTissue culture
31	11-02-2021	P.SuryaKala	III CBZ	PrinciplesofPanttissueculture
32	11-02-2021	M. Pavani	III CBZ	EffectofTemperature
33	16-02-2021	G.DurgaBhavani	II CBZ	Annonaceae
34	16-02-2021	M.Sravani	II CBZ	Euphorbiaceae
35	16-02-2021	G. Pavani	II CBZ	StructureofEmbryosac
36	16-02-2021	B.Sravani	II CBZ	MonosporicEmbryosac
37	16-02-2021	P.Bharathi	II CBZ	Polyembryony
38	16-02-2021	K.Bhargavi	II CBZ	Embryosac Types
39	20-02-2021	P.Neelavathi	III CBZ	DihybridHybridization
40	20-02-2021	G.Pavani	III CBZ	Linkage
41	20-02-2021	P.Venkatakshmi	III CBZ	StructureofChromosome
42	24-02-2021	P.AdiRaju	III CBZ	Hybridizationmethod
43	02-12-2021	R.Navya	I CBZ	PhytogeographicalregionsofIndia
44	02-12-2021	D. Divya	I CBZ	Bentham&HookerClassification
45	02-12-2021	P.Kavya	I CBZ	StelarEvolution
46	02-12-2021	M.Bhargavi	I CBZ	Pteridophyta-Generalcharacters
47	02-12-2021	G.UshaRani	I CBZ	Gymnosperms-GeneralCharacters
48	22-03-2022	G.sandhya	III CBZ	ApplicationsofrDNatechnology
49	22-03-2022	R.Lavanya	III CBZ	Artificialseeds
50	25-03-2022	K.Viswanath	II CBZ	TypesofVascularbundles
51	25-03-2022	Daivamadhuri	II CBZ	T.SofAnther
52	25-03-2022	G.Navya	II CBZ	HotSpotsinIndia
53	28-03-2022	Ch.Devika	II CBZ	TypesofVascularbundles
54	28-03-2022	G.Meenakshi	II CBZ	Ecologicalpyramids



S.G.A. GOVERNMENT DEGREE COLLEGE

(Re-accredited by NAAC with 'A' Grade, Affiliated to Andhra University)

YELLAMANCHILI - 531055, ANDHRA PRADESH



55	28-03-2022	G.PushpaLakshmi	II CBZ	FoodChain
56	29-03-2022	M.Sravani	III CBZ	EmbryoCulture
57	29-03-2022	K.P.SChandrika	III CBZ	Totipotency
58	29-03-2022	K.Aruna	III CBZ	CloningVectors
59	06-04-2022	G.Kavya	III CBZ	PrinciplesofPlantTissueculture
60	06-04-2022	J.Jyothi	III CBZ	TiPlasmid
61	06-04-2022	P.Bharathi	III CBZ	TransgenicPlants
62	12-04-2022	P.Kavya	II CBZ	Hydrosere
63	12-04-2022	A.Ammaji	IICBZ	ThreatstoBiodiversity
64	12-04-2022	O.kumari	IICBZ	ImpactofTemperature
65	12-04-2022	M.Bhargavi	II CBZ	TypesofVascularBundles
66	12-04-2022	G.UshaRani	II CBZ	Xerosere

B.CHANDRAMOULI
Lecturer in Botany
S.G.A.Govt. Degree College
Yellamanchili - 531055
Visakhapatnam Dist.

Principal
S.G.A.Govt.Degree College
YELLAMANCHILI - 531055
Visakhapatnam District.



S.G.A. GOVERNMENT DEGREE COLLEGE

(Re-accredited by NAAC with 'A' Grade, Affiliated to Andhra University)

YELLAMANCHILI - 531055, ANDHRA PRADESH



DEPARTMENT OF BOTANY



Activity: IICBZIV-SEM Student seminars, 2017-18



Name: B. Sirisha

Topic: Photophosphorylation

Date: 07-03-2018

Name: P. Pushpa

Topic: Mechanism of Enzyme reaction

Date: 07-03-2018



S.G.A. GOVERNMENT DEGREE COLLEGE

(Re-accredited by NAAC with 'A' Grade, Affiliated to Andhra University)

YELLAMANCHILI - 531055, ANDHRA PRADESH



DEPARTMENT OF BOTANY

Activity: IICBZ Student Seminars, 2017-18

Name: R. Naga Lakshmi

Topic: Methods of Sterilization

Date: 07-03-2018



Name: O. Manikyam

Topic: Totipotency Date: 07-03-2018



S.G.A. GOVERNMENT DEGREE COLLEGE

(Re-accredited by NAAC with 'A' Grade, Affiliated to Andhra University)

YELLAMANCHILI - 531055, ANDHRA PRADESH



DEPARTMENT OF BOTANY

Activity: IICBZ Student Seminars, 2018-19



Name: K. Rani Topic: Types of Endosperms

Date: 20-08-2018



Name: G. Nagamani Topic: Principles of Taxonomy

Date: 20-08-2018



S.G.A. GOVERNMENT DEGREE COLLEGE

(Re-accredited by NAAC with 'A' Grade, Affiliated to Andhra University)

YELLAMANCHILI - 531055, ANDHRA PRADESH



DEPARTMENT OF BOTANY

Activity: IICBZ Student Seminars, 2018-19



Name: R. Sreenu Topic: Differences between DNA and RNA

Date: 18-09-2018



Name: S. Raju Topic: Structure of Nucleus

Date: 19-09-2018



S.G.A. GOVERNMENT DEGREE COLLEGE

(Re-accredited by NAAC with 'A' Grade, Affiliated to Andhra University)

YELLAMANCHILI - 531055, ANDHRA PRADESH



DEPARTMENT OF BOTANY

III CBZ Student Seminars, V SEM, 2019-20



Name: B. Gayathri

Topic: Structure of DNA.

Date: 03-08-2019



Name: B. Gayathri

Topic: Structure of DNA.

Date: 03-08-2019



S.G.A. GOVERNMENT DEGREE COLLEGE

(Re-accredited by NAAC with 'A' Grade, Affiliated to Andhra University)

YELLAMANCHILI - 531055, ANDHRA PRADESH



Department of Botany

III CBZ Student Seminar, VSEM, 2019-20



Name: CH. Satya Sravanthi Topic: Importance of Temperature as Ecological factor

Date: 09-08-2019



Name: N. Jayasri Topic: Importance of Light as Ecological factor Date: 09-08-2019



S.G.A. GOVERNMENT DEGREE COLLEGE

(Re-accredited by NAAC with 'A' Grade, Affiliated to Andhra University)

YELLAMANCHILI - 531055, ANDHRA PRADESH



DEPARTMENT OF BOTANY

ICBZ, SEMI & II Student seminars, 2018-19



Name: Ch. Gayathri Topic: Structure of TMV

Date: 20-08-2019



Name: P. Bhavani Topic: Marchantia - General characters

Date: 20-08-2019



S.G.A. GOVERNMENT DEGREE COLLEGE

(Re-accredited by NAAC with 'A' Grade, Affiliated to Andhra University)

YELLAMANCHILI - 531055, ANDHRA PRADESH



DEPARTMENT OF BOTANY

ICBZ Student Seminar, 2019-20



Name: G. Sandhya Topic: Funaria Capsule Date: 23-01-2020



Name: K. Syamala Topic: Boerhavia stem T.S Date: 23-01-2020



S.G.A. GOVERNMENT DEGREE COLLEGE

(Re-accredited by NAAC with 'A' Grade, Affiliated to Andhra University)

YELLAMANCHILI - 531055, ANDHRA PRADESH



DEPARTMENT OF BOTANY IICBZ Student Seminar, IV SEM, 2019-20



Name: B. Tulasi Naga Lakshmi Topic: Macroelements. Date: 06-02-2020



Name: P. Suryakala Topic: Mechanism of Enzyme action and factors affecting rate of Enzyme activity Date: 06-02-2020



Name: J. Jayasree Topic: Mechanism of Ascent of Sap Date: 06-02-2020



S.G.A. GOVERNMENT DEGREE COLLEGE

(Re-accredited by NAAC with 'A' Grade, Affiliated to Andhra University)

YELLAMANCHILI - 531055, ANDHRA PRADESH



SGA Govt. Degree College,

Yellamanchil Department of Botany

IIICBZ, SEM-VI

Studentseminars, 2019-20



Name: V. Krupa Rani Topic: Principles of DNA Technology

Date: 22-02-2020



Name: N. Jayasri Topic: Golden Rice

Date: 22-02-2020



Name: B. Gayathri Topic: Principles of Tissue Culture

Date: 22-02-2020



S.G.A. GOVERNMENT DEGREE COLLEGE

(Re-accredited by NAAC with 'A' Grade, Affiliated to Andhra University)

YELLAMANCHILI - 531055, ANDHRA PRADESH



DEPARTMENT OF BOTANY
III CBZ, SEM-VI Student Seminars, 2019-20



Name: R. Sunitha Topic: *Gloriosa superba* - Ethnobotanical importance Date: 28-12-2020



Name: N. Triveni Topic: *Rauvolfia serpentina* Ethnobotanical importance Date: 28-12-2020



S.G.A. GOVERNMENT DEGREE COLLEGE

(Re-accredited by NAAC with 'A' Grade, Affiliated to Andhra University)

YELLAMANCHILI - 531055, ANDHRA PRADESH



Department of Botany

IICBZ Student Seminars, SEM-III, 2020-21



Name: Ch. Gayathri Topic: Polyembryony and Types Date: 11-02-2021



Name: K. Uma Maheswari Topic: Asteraceae Family Date: 11-02-2021

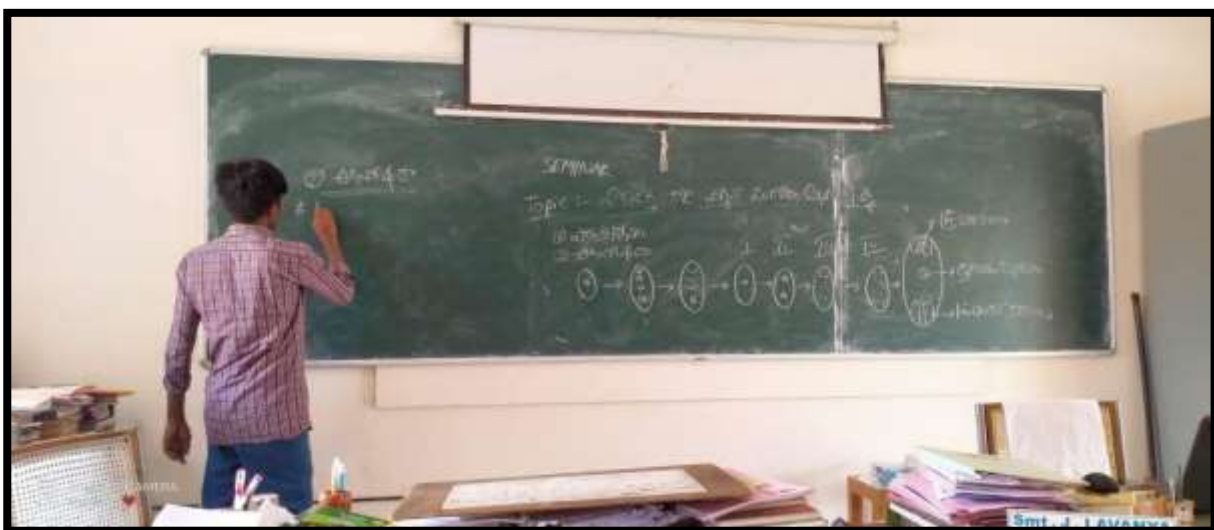

Name: V. Vara Prasad Topic: Monosporic Embryo Sac Date: 11-02-2021



S.G.A. GOVERNMENT DEGREE COLLEGE

(Re-accredited by NAAC with 'A' Grade, Affiliated to Andhra University)

YELLAMANCHILI - 531055, ANDHRA PRADESH



DEPARTMENT OF BOTANY

IICBZ Student Seminars, SEM-III, 2020-21



Name: D. Dhamani Topic: Plant Kingdom Classification Date: 11-02-2021



Name: G. Sandhya Topic: Microsporogenesis Date: 11-02-2021



S.G.A. GOVERNMENT DEGREE COLLEGE

(Re-accredited by NAAC with 'A' Grade, Affiliated to Andhra University)

YELLAMANCHILI - 531055, ANDHRA PRADESH



DEPARTMENT OF BOTANY

Activity: III CBZ Student Seminar, 2020-21

VSEM,

Date: 11-02-2021



Pikki Koti, Topic: Steps involved in Plant Tissue Culture

Date: 11-02-2021



Name: P. Suryakala

Topic: Principles of Tissue Culture

Date: 11-02-2021



Name: M. Pavani

Topic: Effect of Temperature

Date: 11-02-2021



S.G.A. GOVERNMENT DEGREE COLLEGE

(Re-accredited by NAAC with 'A' Grade, Affiliated to Andhra University)

YELLAMANCHILI - 531055, ANDHRA PRADESH



Department of Botany
IICBZ Student Seminars, 2020-21

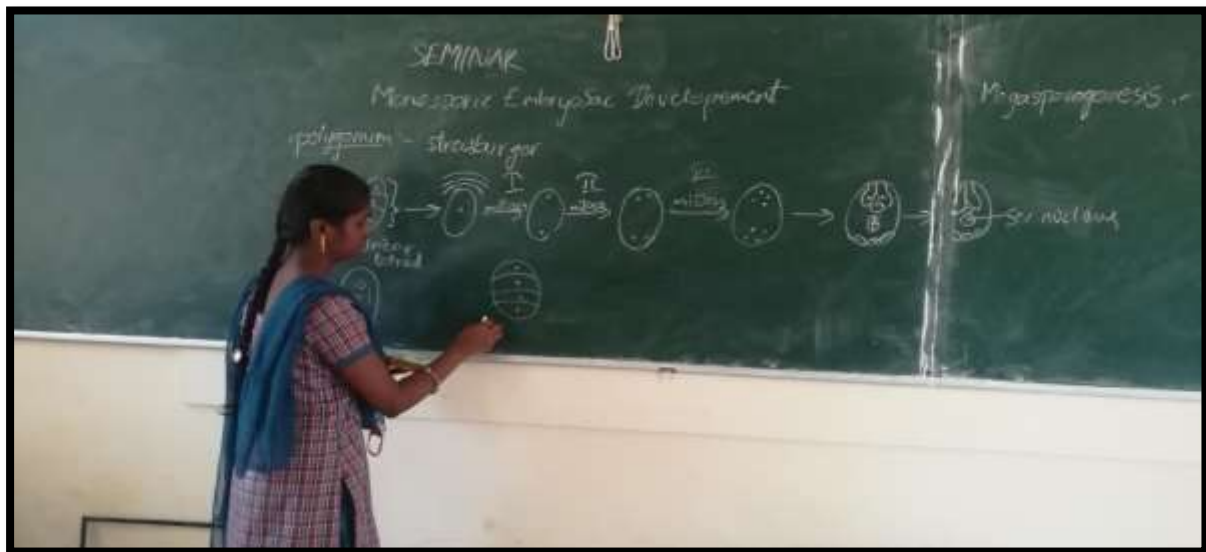

Name: B. Sravani Topic: Monosporic Embryosac development Date: 11-02-2021



Name: P. Bharathi Topic: Polyembryony Date: 16-02-2021



Name: K. Bhargavi Topic: Embryosacs-Types Date: 16-02-2021



S.G.A. GOVERNMENT DEGREE COLLEGE

(Re-accredited by NAAC with 'A' Grade, Affiliated to Andhra University)

YELLAMANCHILI - 531055, ANDHRA PRADESH



DEPARTMENT OF BOTANY

II

CBZ Student Seminars, 2020-21



Name: G. Durga Bhvani Topic: Annonaceae Family Date: 16-02-2021



Name: M. Sravani Topic: Euphorbiaceae Family Date: 16-02-2021



Name: G. Pavani Topic: Structure of Embryosac Date: 16-02-2021



S.G.A. GOVERNMENT DEGREE COLLEGE

(Re-accredited by NAAC with 'A' Grade, Affiliated to Andhra University)

YELLAMANCHILI - 531055, ANDHRA PRADESH



DEPARTMENT OF BOTANY

III CBZ Student Seminars, 2020-21



Name: P. Neelavathi

Topic: Dihybrid Hybridization

Date: 20-02-2021



Name: G. Pavani

Topic: Linkage

Date: 20-02-2021



S.G.A. GOVERNMENT DEGREE COLLEGE

(Re-accredited by NAAC with 'A' Grade, Affiliated to Andhra University)

YELLAMANCHILI - 531055, ANDHRA PRADESH



DEPARTMENT OF BOTANY

III CBZ Student Seminars, 2020-21



Name: P.Venkata Lakshmi

Topic: Structure of Chromosome

Date: 20-02-2021



Name: P.AdiRaju

Topic: Hybridization technique

Date: 24-02-2021



S.G.A. GOVERNMENT DEGREE COLLEGE

(Re-accredited by NAAC with 'A' Grade, Affiliated to Andhra University)

YELLAMANCHILI - 531055, ANDHRA PRADESH



DEPARTMENT OF BOTANY

ICBZ, SEM-II Student Seminars, 2020-21



Name: M. Bhargavi Topic: Pteridophyta - General characters

Date: 02-12-2021



Name: G. Usha Rani Topic: Gymnosperms - General characters

Date: 02-12-2021



S.G.A. GOVERNMENT DEGREE COLLEGE

(Re-accredited by NAAC with 'A' Grade, Affiliated to Andhra University)

YELLAMANCHILI - 531055, ANDHRA PRADESH



DEPARTMENT OF BOTANY

I CBZ, SEM-II Student Seminars, 2020-21



Name: R. Navya Topic: Phytogeographical regions of India

Date: 02-12-2021



Name: D. Divya Topic: Bentham & Hooker's Classification

Date: 02-12-2021



Name: P. Kavya

Topic: Stellar Evolution in Pteridophytes

Date: 02-12-2021



S.G.A. GOVERNMENT DEGREE COLLEGE

(Re-accredited by NAAC with 'A' Grade, Affiliated to Andhra University)

YELLAMANCHILI - 531055, ANDHRA PRADESH



SGAGovt.DegreeCollege,Yellamanchili

Department of Botany

IIICBZ,SEM-VI

Student seminars, 2021-22



Name:G.Sandhya Topic:ApplicationsofGeneticEngineering

Date:22-03-2022



Name: R.Lavanya Topic: SomaticEmbryosandArtificialSeeds

Date:22-03-2022



S.G.A. GOVERNMENT DEGREE COLLEGE

(Re-accredited by NAAC with 'A' Grade, Affiliated to Andhra University)

YELLAMANCHILI - 531055, ANDHRA PRADESH



SGA Govt. Degree
College, Yellamanchili Department of Botany

IICBZ, SEM-III Student Seminars, 2021-22



Name: K. Viswanth

Topic: Types of Vascular Bundles

Date: 25-03-2022



Name: Daiva Madhuri

Topic: T. Sof Anther

Date: 25-03-2022



Name: G. Navya Topic: Hotspots in India

Date: 25-03-2022



S.G.A. GOVERNMENT DEGREE COLLEGE

(Re-accredited by NAAC with 'A' Grade, Affiliated to Andhra University)

YELLAMANCHILI - 531055, ANDHRA PRADESH



SGA Govt. Degree
College, Yellamanchili Department of Botany

IICBZ, SEM-III Student Seminars, 2021-22



Name: CH. Devika Topic: Types of Vascular Bundles

Date: 28-03-2022



Name: G. Meenakshi Topic: Ecological Pyramids

Date: 28-03-2022



Name: G. Pushpa Lakshmi Topic: Food Chain

Date: 28-03-2022



S.G.A. GOVERNMENT DEGREE COLLEGE

(Re-accredited by NAAC with 'A' Grade, Affiliated to Andhra University)

YELLAMANCHILI - 531055, ANDHRA PRADESH



SGA Govt. Degree
College, Yellamanchili Department of Botany

IIICBZ, SEM-VI

Student Seminars, 2021-22



Name: M. Sravani Topic: Embryo Culture

Date: 29-03-2022



Name: K. P. S. Chandrika Topic: Totipotency and Tissue Culture

Date: 29-03-2022



Name: K. Aruna Topic: Cloning Vectors

Date: 29-03-2022



S.G.A. GOVERNMENT DEGREE COLLEGE

(Re-accredited by NAAC with 'A' Grade, Affiliated to Andhra University)

YELLAMANCHILI - 531055, ANDHRA PRADESH



SGA Govt. Degree College,
Yellamanchili Department of Botany

IIICBZ, SEM-VI

Student seminars, 2021-22



Name: G.Kavya

Topic: Principles of Plant Tissue Culture

Date: 06-04-2022



Name: J.Jyothi

Topic: Ti-Plasmid

Date: 06-04-2022



Name: P.Bharathi

Topic: Transgenic Plants

Date: 06-04-2022



S.G.A. GOVERNMENT DEGREE COLLEGE

(Re-accredited by NAAC with 'A' Grade, Affiliated to Andhra University)

YELLAMANCHILI - 531055, ANDHRA PRADESH



SGA Govt. Degree College,
Yellamanchili Department of Botany
IICBZ, SEM-III Student seminars, 2021-22



Name: P. Kavya Topic: Hydrosere

Date: 12-04-2022



Name: D. Ammaji Topic: Threats to Biodiversity

Date: 12-04-2022



Name: O. Kumari Topic: Impact of Temperature on Plants

Date: 12-04-2022



S.G.A. GOVERNMENT DEGREE COLLEGE

(Re-accredited by NAAC with 'A' Grade, Affiliated to Andhra University)

YELLAMANCHILI - 531055, ANDHRA PRADESH



SGA Govt. Degree College,
Yellamanchili Department of Botany

IICBZ, SEM-III Student seminars, 2021-22



Name: M. Bhargavi

Topic: Types of Vascular Bundles

Date: 12-04-2022



Name: G. Usha Rani

Topic: Xerophytes

Date: 12-04-2022



S.G.A. GOVERNMENT DEGREE COLLEGE

(Re-accredited by NAAC with 'A' Grade, Affiliated to Andhra University)

YELLAMANCHILI - 531055, ANDHRA PRADESH



S.G.A Govt. Degree College Yellamanchili

Department of MATHEMATICS

Departmental activities – Student Seminars 2016 -2021

S. No	Date	Name of the student	Group	Name of the topic	Remarks
1	28-12-16	R.Ramya	III MPC	Dimension of a vector space	
2	23-01-16	R.Varalakshami	III MPC	Cayley's Theorem	
3	29-01-16	S.Nirmala	III MPC	Homomorphism of the vector space	
4	22-02-16	K.Venkata Lakshmi	III MPC	GAUSS' s theorem	
5	16-03-16	D.Darla	III MPC	Newton divided difference interpolation formulae	
6	25-03-16	Y.Ramu	III MPC	Linear transformation of vector	
7	08-04-16	N.Indraja	III MPC	Cauchy Schwarz's inequality	
8	09-10-18	Lova laxmi	III MPC	Interpolation	
9	20-06-19	K.Chatarya	III MPC	Differential equation	
10	27-06-19	Ch.srilekha	III MPC	Group theory	
11	03-07-19	P.Tulasi	III MPC	Orthogonal trajectories	
12	20-07-19	P.Raju	III MPC	Infinite series	
13	17-02-21	P.Pavani	II MPC	Fundamental Theorem	
14	23-02-21	U. Chitti Jyothi	II MPC	Kernel of homomorphism	
15	25-02-21	N.Anuradha	II MPC	Kernel of homomorphism	
16	26-02-21	K.Anitha	II MPC	Normal subgroups	
17	26-02-21	S.Umadevi, M.Krishanaveni	I MPC	Linear Differentiation	
18	06-03-21	M.Gayathri, Y.Nagadurga	I MPC	Bernoulli's Theorem	
19	10-03-21	K.Anuradha, Y.Laya	II MPC	Sequences	
20	27-03-21	V.Simhadri, B.Sivalakshmi	I MPCs	Orthogonal Trajectories	
21	05-04-21	K.Vishalakshi, V.Bhanupriya	II MPC	Series	
22	10-04-21	P.Padma, N.Lakshmidevi	I MPC	Clairaut's Equation	
23	24-04-21	K.Sirisha, K.B.N.Bhuvanewari	I MPC	Solutions of non homogenous linear differential equations	
24	07-06-21	N.Anuradha, K.Anusha	II MPC	Limits and continuous	
25	13-07-21	R.Ganaga Bhavani, N.Ganeshini	I MPC	Finding the general solutions of variation parameters	
26	19-07-21	P.Madhava, K.Prasadhu	II MPC	Differentiation	
27	30-07-21	B.Balaji, S.Gayathri	I MPC	Cauchy-Euler Equation	
28	18-08-21	M.Sandeep	I MPCs	Legendre's Equation	



S.G.A. GOVERNMENT DEGREE COLLEGE

(Re-accredited by NAAC with 'A' Grade, Affiliated to Andhra University)

YELLAMANCHILI - 531055, ANDHRA PRADESH

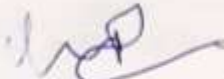

29	25-08-21	P.Pavani, U.Jyothi	II MPC	Reimann Integration	
30	12-10-21	D.Sathyadurga	III MPC	Ring theory	
31	13-10-21	B.Srinivasa rao	III MPC	Vector space	
32	23-10-21	U.Chitti Jyothi, P.Priyanka	III MPC	Sub rings, Homo morphism	
33	27-10-21	N.Lakshmi devi N.Leela lakshmi	I MPC	Bisectors of angles between two planes	
34	08-11-21	P.Madhavi, K.Vishalakshmi	III MPC	Vector Differentiation, Basics & Dimension	
35	16-11-21	M.Ashok S.Gayathri	I MPC	Orthogonal projection on a plane	
36	22-11-21	K.Navya A.Naga puspha	I MPC	The S.D between two lines	
37	29-11-21	K.Deepika K.Pavani Tejasri	I MPC	Length of the perpendicular from a given point to a given line	
38	29-11-21	K.Anusha, A.Lahari	III MPC	Vector Integration, Linear transformation	
39	13-12-21	V.Simhadri B.Balaji	I MPC	Intersection of two spheres	
40	15-12-21	P.Pavani, T.Aruna	III MPC	Vector integration Applications, Matrix	
41	18-12-21	M.Ramani S.Ganesri sai	I MPC	Equation of a circle sphere through a given circle	
42	22-11-21	P.Durga vani N.Ganeshini	I MPC	Equation of the right cone with a given vertex	

Head of the Department
Department of Mathematics
S.G.A. Govt. Degree College
Yellamanchili-531055
ANAKAPALLI District

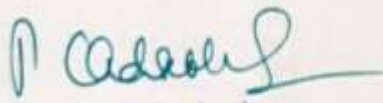
Principal
S.G.A. Govt. Degree College
Yellamanchili-531055
Anakapalli District. (A.P.)



S.G.A. GOVERNMENT DEGREE COLLEGE

(Re-accredited by NAAC with 'A' Grade, Affiliated to Andhra University)

YELLAMANCHILI - 531055, ANDHRA PRADESH



DEPARTMENT OF MATHEMATICS STUDENT SEMINAR



Student Seminar by Jyothi 1st B.sc dated 21-08-19

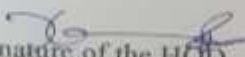

Student Seminar by Leelavathi 1st B.sc dated 08-09-19

Signature of the HOD

Head of the Department
Department of Mathematics
S.G.A. Govt. Degree College
Yellamanchili 531055
ANAPURU District

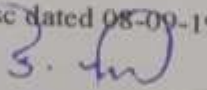

Signature of the Principal



S.G.A. GOVERNMENT DEGREE COLLEGE

(Re-accredited by NAAC with 'A' Grade, Affiliated to Andhra University)

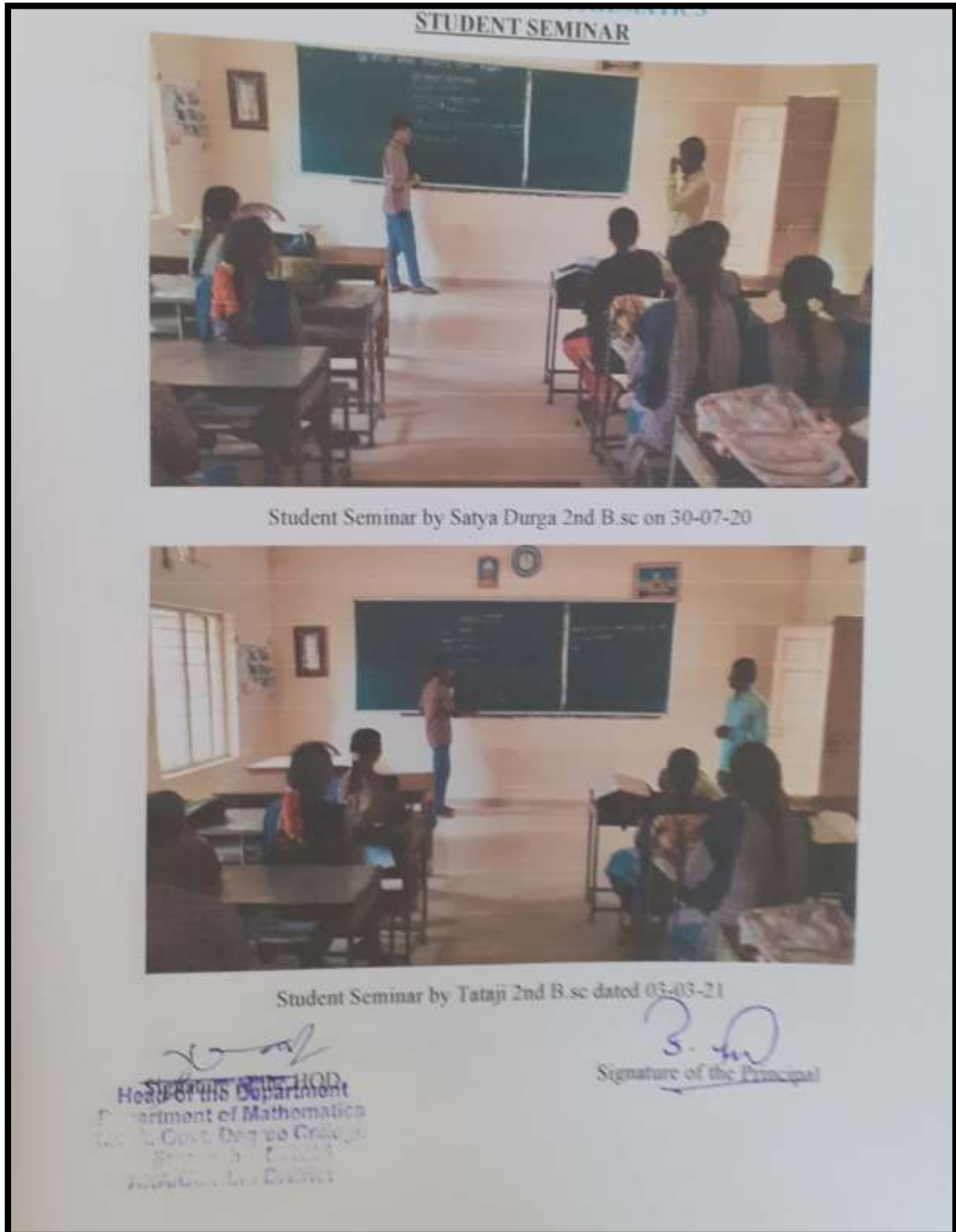
YELLAMANCHILI - 531055, ANDHRA PRADESH





S.G.A. GOVERNMENT DEGREE COLLEGE

(Re-accredited by NAAC with 'A' Grade, Affiliated to Andhra University)

YELLAMANCHILI - 531055, ANDHRA PRADESH



DEPARTMENT OF MATHEMATICS STUDENT SEMINAR



Student Seminar by Balaji, I B.Sc Dated 16.03.2021



Student Seminar by Umadevi, I B.Sc Dated 12.07.2021

Head of the Department
Signature of the HOD
Department of Mathematics
S.G.A. Govt. Degree College
Yellamanchili-531055
AKAPALLI District

Signature of the Principal



S.G.A. GOVERNMENT DEGREE COLLEGE

(Re-accredited by NAAC with 'A' Grade, Affiliated to Andhra University)

YELLAMANCHILI - 531055, ANDHRA PRADESH



DEPARTMENT OF MATHEMATICS
STUDENT SEMINAR



Student Seminar by Swathi dated 08.04.2021

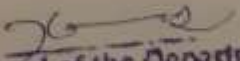

Student Seminar by Bhuvaneswari dated 08.07.2021

Head of the Department
Department of Mathematics
S.G.A. Govt. Degree College
Yellamanchili-531055
ANAKAPALLI District

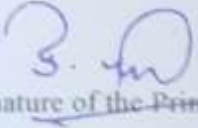
Signature of the Principal



S.G.A. GOVERNMENT DEGREE COLLEGE

(Re-accredited by NAAC with 'A' Grade, Affiliated to Andhra University)

YELLAMANCHILI - 531055, ANDHRA PRADESH



DEPARTMENT OF CHEMISTRY

STUDENT SEMINAR-2018-19



Student seminar by B.Sc student on 25-

10-2018 Topic: Types

of Chemical Reactions

Name: K.sivasaiShanker

Head of the Department
Department of Chemistry
S.G.A. Govt Degree College
Yellamanchili-531 055

Principal
S.G.A. Govt. Degree College
YELLAMANCHILI - 531 055
Visakhapatnam District.



S.G.A. GOVERNMENT DEGREE COLLEGE

(Re-accredited by NAAC with 'A' Grade, Affiliated to Andhra University)

YELLAMANCHILI - 531055, ANDHRA PRADESH



Student seminar by I B.Sc student on 15-11-2018

Topic : Addition reactions and Substitution reactions

Name: N.Nookesh

Head of the Department
Department of Chemistry
S.G.A. Govt Degree College
Yellamanchili-531 055

Principal
S.G.A. Govt Degree College
YELLAMANCHILI - 531 055
Visakhapatnam District.



S.G.A. GOVERNMENT DEGREE COLLEGE

(Re-accredited by NAAC with 'A' Grade, Affiliated to Andhra University)

YELLAMANCHILI - 531055, ANDHRA PRADESH



Student seminar by B.Sc student 31-07-

2021 Topic; Solid state - Bragg's equation

Name: G. Kavya

Head of the Department
Department of Chemistry
S.G.A. Govt Degree College
Yellamanchili-531 055

Principal
S.G.A. Govt. Degree College
YELLAMANCHILI - 531 055
Visakhapatnam District.



S.G.A. GOVERNMENT DEGREE COLLEGE

(Re-accredited by NAAC with 'A' Grade, Affiliated to Andhra University)

YELLAMANCHILI - 531055, ANDHRA PRADESH



Student seminar by III B.Sc student on 22-12-2021

Topic: Carnot cycle

Name: K. Anitha

Head of the Department
Department of Chemistry
S.G.A. Govt Degree College
Yellamanchili-531 055

Principal
S.G.A. Govt. Degree College
YELLAMANCHILI - 531 055
Visakhapatnam District.



S.G.A. GOVERNMENT DEGREE COLLEGE

(Re-accredited by NAAC with 'A' Grade, Affiliated to Andhra University)

YELLAMANCHILI - 531055, ANDHRA PRADESH



Student seminar by B.Sc student on 19-08-2021 Topic: Dilute solutions

Name: D. Satya Durga

Head of the Department
Department of Chemistry
S.G.A. Govt Degree College
Yellamanchili-531 055

Principal
S.G.A. Govt. Degree College
YELLAMANCHILI - 531 055
Visakhapatnam District.



S.G.A. GOVERNMENT DEGREE COLLEGE

(Re-accredited by NAAC with 'A' Grade, Affiliated to Andhra University)

YELLAMANCHILI - 531055, ANDHRA PRADESH



Studentseminarbyl B.Sc studenton 23-12-2021

Topic:Thermodynamics

Name:B.Leelavathi

Head of the Department
Department of Chemistry
S.G.A. Govt Degree College
Yellamanchili-531 055

Principal
S.G.A.Govt.Degree College
YELLAMANCHILI - 531 055
Visakhapatnam District.



S.G.A. GOVERNMENT DEGREE COLLEGE

(Re-accredited by NAAC with 'A' Grade, Affiliated to Andhra University)

YELLAMANCHILI - 531055, ANDHRA PRADESH



StudentseminarbyIIB.Scstudent on 26-08-2022

Topic:Hetero cycliccompounds

Name:K.B.N.Bhuvaneshwari

Head of the Department
Department of Chemistry
S.G.A. Govt Degree College
Yellamanchili-531 055

Principal
S.G.A.Govt.Degree College
YELLAMANCHILI - 531 055
Visakhapatnam District.



S.G.A. GOVERNMENT DEGREE COLLEGE

(Re-accredited by NAAC with 'A' Grade, Affiliated to Andhra University)

YELLAMANCHILI - 531055, ANDHRA PRADESH



StudentseminarbyIIB.Scstudent on 26-08-2022

Topic:StructureofGlucose

Name:B.Sivalakshmi

Head of the Department
Department of Chemistry
S.G.A. Govt Degree College
Yellamanchili-531 055

Principal
S.G.A.Govt.Degree College
YELLAMANCHILI - 531 055
Visakhapatnam District.



S.G.A. GOVERNMENT DEGREE COLLEGE

(Re-accredited by NAAC with 'A' Grade, Affiliated to Andhra University)

YELLAMANCHILI - 531055, ANDHRA PRADESH



StudentseminarbyIIB.Scstudent on 26-08-

2022Topic:Organo metallic compounds

Name:R.D.Madhuri

Head of the Department
Department of Chemistry
S.G.A. Govt Degree College
Yellamanchili-531 055

Principal
S.G.A.Govt.Degree College
YELLAMANCHILI - 531 055
Visakhapatnam District.



S.G.A. GOVERNMENT DEGREE COLLEGE

(Re-accredited by NAAC with 'A' Grade, Affiliated to Andhra University)

YELLAMANCHILI - 531055, ANDHRA PRADESH



StudentseminarbyIIB.Scstudent on 08-09-

2022Topic:EIGHTEENELECTRONRULE

Name :M.Krishnaveni

Head of the Department
Department of Chemistry
S.G.A. Govt Degree College
Yellamanchili-531 055

Principal
S.G.A.Govt.Degree College
YELLAMANCHILI - 531 055
Visakhapatnam District.



S.G.A. GOVERNMENT DEGREE COLLEGE

(Re-accredited by NAAC with 'A' Grade, Affiliated to Andhra University)

YELLAMANCHILI - 531055, ANDHRA PRADESH



Student Seminar - III B.A.

Topic: ఆంధ్రప్రదేశ్ లోని వాణిజ్య పరిస్థితులు

Presented by: M. Zahana Labshmi

Date: 21/9/17



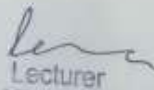

Lecturer
Dept. of Economics & RI
S.G.A. Govt. Degree College
Yellamanchili - 531 055

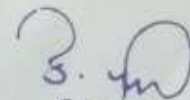

Principal
S.G.A. Govt. Degree College
Yellamanchili - 531 055



S.G.A. GOVERNMENT DEGREE COLLEGE

(Re-accredited by NAAC with 'A' Grade, Affiliated to Andhra University)

YELLAMANCHILI - 531055, ANDHRA PRADESH



Topic: అంబాబా - అంబాబా అంబా అంబా

Name of the Student

Signature

P. Sai Lakshmi	P. Sai lakshmi
G. Durga Mahesh	G. mahesh
D. Sai Lakshmi	D. Sai lakshmi
U. vijaya	U. vijaya
B. Sowjanya	B. Sowjanya
J. Swarna	J. Swarna
S.K. Meharishi	S.K. Meharishi
R. Sri	R. Sri
B. Chandrakala	B. Chandrakala
P. Devi	P. Devi
P. Tulasi Lakshmi	P. Tulasi Lakshmi
J. Love Durga Devi	J. Love Durga Devi
B. Sathya	B. Sathya
B. Natarajamma	B. Natarajamma
K. Sai	K. Sai



S.G.A. GOVERNMENT DEGREE COLLEGE

(Re-accredited by NAAC with 'A' Grade, Affiliated to Andhra University)

YELLAMANCHILI - 531055, ANDHRA PRADESH



P. Vasa Prasad

V. Lakshmana Rao

K. N. M. Beemani

N. Ravi

S. Govind

G. Mahesh

P. Venkatesh

V. Lakshmana Rao

K. N. M. Beemani

N. Ravi

S. Govind

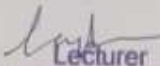
Lecturer
Dept. of Economics & RI
S.G.A. Govt. Degree College
Yellamanchili - 531 055

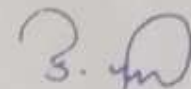
Principal
S.G.A. Govt. Degree College
Yellamanchili - 531 055



S.G.A. GOVERNMENT DEGREE COLLEGE

(Re-accredited by NAAC with 'A' Grade, Affiliated to Andhra University)

YELLAMANCHILI - 531055, ANDHRA PRADESH



Student Seminar - III BA.

Topic: విద్యార్థుల మన దురస్థితి గురించి

Presented by: R. Seetha

18/12/2017



R. Seetha
Lecturer

Dept. of Economics & RI
S.G.A. Govt. Degree College
Yellamanchili - 531 055

S. M.

Principal
S.G.A. Govt. Degree College
Yellamanchili - 531 055



S.G.A. GOVERNMENT DEGREE COLLEGE

(Re-accredited by NAAC with 'A' Grade, Affiliated to Andhra University)

YELLAMANCHILI - 531055, ANDHRA PRADESH



S.G.A. GOVERNMENT DEGREE COLLEGE

(Re-accredited by NAAC with 'A' Grade, Affiliated to Andhra University)

YELLAMANCHILI - 531055, ANDHRA PRADESH



DEPARTMENT OF ECONOMICS



Student Seminar conducted by III BA Students on 07.12.2021.

Topic: The Causes of Poverty in India

Presented by V. Indumathi,

Lecturer in Economics
Dept. of Economics & R
S.G.A. Govt. Degree College
Yellamanchili - 531 055

Lecturer in Economics
Dept. of Economics & R
S.G.A. Govt. Degree College
Yellamanchili - 531 055

Principal
S.G.A. Govt. Degree College
YELLAMANCHILI - 531 055
Visakhapatnam District



S.G.A. GOVERNMENT DEGREE COLLEGE

(Re-accredited by NAAC with 'A' Grade, Affiliated to Andhra University)

YELLAMANCHILI - 531055, ANDHRA PRADESH



S.G.A. GOVERNMENT DEGREE COLLEGE

(Re-accredited by NAAC with 'A' Grade, Affiliated to Andhra University)
YELLAMANCHILI - 531055, ANDHRA PRADESH



DEPARTMENT OF ECONOMICS



STUDENT SEMINAR CONDUCTED FOR II BA STUDENTS ON 02.08.2021

TOPIC: PHASES OF TRADE CYCLES

PRESENTED BY: B.BHANU PRAKASH

Signature of the Lecturer
Lecturer

Dept. of Economics & RI
S.G.A. Govt. Degree College
Yellamanchili - 531 055

Signature of the HOD
Lecturer

Dept. of Economics & RI
S.G.A. Govt. Degree College
Yellamanchili - 531 055

Signature of the Principal
Principal

S.G.A. Govt. Degree College
YELLAMANCHILI - 531 055
Vizianagaram District



S.G.A. GOVERNMENT DEGREE COLLEGE

(Re-accredited by NAAC with 'A' Grade, Affiliated to Andhra University)

YELLAMANCHILI - 531055, ANDHRA PRADESH



S.G.A. GOVERNMENT DEGREE COLLEGE

(Re-accredited by NAAC with 'A' Grade, Affiliated to Andhra University)

YELLAMANCHILI - 531055, ANDHRA PRADESH



DEPARTMENT OF ECONOMICS



Student Seminar Conducted by I.B.A Students on 15-12-2021

Topic : The concepts of National Income

Presented by S.Dhana Laxmi

Signature of the Lecturer
Lecturer

Dept. of Economics & RI
S.G.A. Govt. Degree College
Yellamanchili - 531 055

Signature of the HOD
Lecturer

Dept. of Economics & RI
S.G.A. Govt. Degree College
Yellamanchili - 531 055

Signature of the Principal
Principal

S.G.A. Govt. Degree College
YELLAMANCHILI - 531 055
Visakhapatnam District



S.G.A. GOVERNMENT DEGREE COLLEGE

(Re-accredited by NAAC with 'A' Grade, Affiliated to Andhra University)

YELLAMANCHILI - 531055, ANDHRA PRADESH



Group Discussions

Activity: Group discussion Group: II CBZ, 2017-18

Topic: Bifurcation of Andhrapradesh Date:07-03-2018





S.G.A. GOVERNMENT DEGREE COLLEGE

(Re-accredited by NAAC with 'A' Grade, Affiliated to Andhra University)

YELLAMANCHILI - 531055, ANDHRA PRADESH



I CBZ, SEM-II, Group Discussion, 2018-19

Topic: Child Marriages

Date: 10-02-2019



Smt J. Lavanya and Students were in Group Discussion.



S.G.A. GOVERNMENT DEGREE COLLEGE

(Re-accredited by NAAC with 'A' Grade, Affiliated to Andhra University)

YELLAMANCHILI - 531055, ANDHRA PRADESH



I CBZ, SEM-I, Group Discussion, 2019-20

Topic: Parents at Old age Homes

Date: 09-09-2019



Smt J. Lavanya and Students were in Group Discussion.



S.G.A. GOVERNMENT DEGREE COLLEGE

(Re-accredited by NAAC with 'A' Grade, Affiliated to Andhra University)

YELLAMANCHILI - 531055, ANDHRA PRADESH



II CBZ, SEM-III, Group Discussion, 2019-20

Topic: Women Education

Date: 17-02-2020



Dr. B. Chandramouli and Students were in Group Discussion.



S.G.A. GOVERNMENT DEGREE COLLEGE

(Re-accredited by NAAC with 'A' Grade, Affiliated to Andhra University)

YELLAMANCHILI - 531055, ANDHRA PRADESH



II CBZ, Students , 2019-20

Name of activity: Group Discussion, Date: 20-02-2020

Topic: Pollution and Global warming



Dr.B.Chandramouli, organized Group Discussion to II CBZ Students



Participation of Students in Group Discussion



S.G.A. GOVERNMENT DEGREE COLLEGE

(Re-accredited by NAAC with 'A' Grade, Affiliated to Andhra University)

YELLAMANCHILI - 531055, ANDHRA PRADESH



Activity: III CBZ Group discussion, 2020-21

Topic: Role of students in Politics Date: 18-08-2021



Smt. J. Lavanya, Lecturer in Botany and students in the Group discussion



S.G.A. GOVERNMENT DEGREE COLLEGE

(Re-accredited by NAAC with 'A' Grade, Affiliated to Andhra University)

YELLAMANCHILI - 531055, ANDHRA PRADESH



I CBZ Group Discussion, 2021-22

Date:-16-11-2021



Dr. B. Chandramouli, Lecturer in Botany and Students in the Group Discussion program



S.G.A. GOVERNMENT DEGREE COLLEGE

(Re-accredited by NAAC with 'A' Grade, Affiliated to Andhra University)

YELLAMANCHILI - 531055, ANDHRA PRADESH



I CBZ, I SEM Students , 2020-21

Name of activity: Group Discussion, Date:02-12-2021



Participation of students in Group Discussion



S.G.A. GOVERNMENT DEGREE COLLEGE

(Re-accredited by NAAC with 'A' Grade, Affiliated to Andhra University)

YELLAMANCHILI - 531055, ANDHRA PRADESH



Group Discussion Activity conducted by S.M.Rafuddeen Lecturer in Physics, SGA GDC, Yallamanchili, dated 03.12.2019



S.G.A. GOVERNMENT DEGREE COLLEGE

(Re-accredited by NAAC with 'A' Grade, Affiliated to Andhra University)

YELLAMANCHILI - 531055, ANDHRA PRADESH



Group Discussion Activity conducted by S.M.Rafuddeen Lecturer in Physics, SGA GDC, Yallamanchili, dated 08.07.2020



S.G.A. GOVERNMENT DEGREE COLLEGE

(Re-accredited by NAAC with 'A' Grade, Affiliated to Andhra University)

YELLAMANCHILI - 531055, ANDHRA PRADESH



“GROUP DISCUSSION” Conducted to III-B.Sc Students Dated: 16-12-2020.



S.G.A. GOVERNMENT DEGREE COLLEGE

(Re-accredited by NAAC with 'A' Grade, Affiliated to Andhra University)

YELLAMANCHILI - 531055, ANDHRA PRADESH



GROUP DISCUSSION BY III- B.Sc STUDENTS DATED: 29-12-2020

Soy. Laxindin
Lecturer in Physics
SGA GDC
YELLAMANCHILI

3m
Principal
S.G.A. Govt. Degree College
YELLAMANCHILI - 531 055
Vizalhaputnam District.



S.G.A. GOVERNMENT DEGREE COLLEGE

(Re-accredited by NAAC with 'A' Grade, Affiliated to Andhra University)

YELLAMANCHILI - 531055, ANDHRA PRADESH

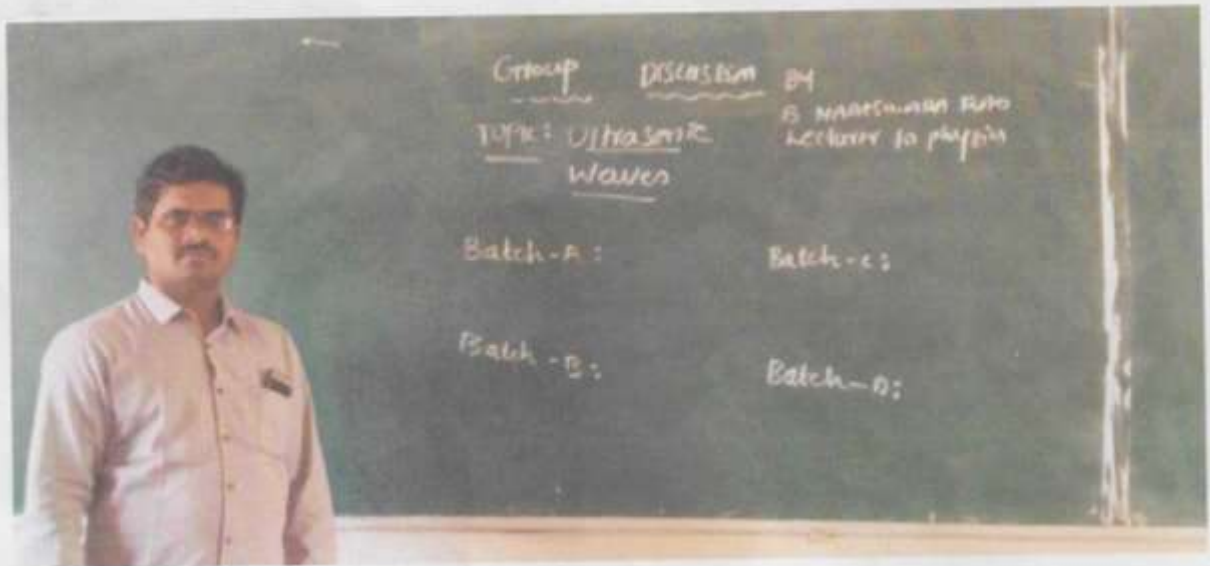

Group Discussion conducted to I B.Sc students dated 11.03.2021



S.G.A. GOVERNMENT DEGREE COLLEGE

(Re-accredited by NAAC with 'A' Grade, Affiliated to Andhra University)

YELLAMANCHILI - 531055, ANDHRA PRADESH



“Group Discussion” to I-B.Sc SEM-I Students Dated: 24-03-2021.



S.G.A. GOVERNMENT DEGREE COLLEGE

(Re-accredited by NAAC with 'A' Grade, Affiliated to Andhra University)

YELLAMANCHILI - 531055, ANDHRA PRADESH



“GROUP DISCUSSION” CONDUCTED TO III-B.SC STUDENTS DATED 05-08-2021.



S.G.A. GOVERNMENT DEGREE COLLEGE

(Re-accredited by NAAC with 'A' Grade, Affiliated to Andhra University)

YELLAMANCHILI - 531055, ANDHRA PRADESH



Student Group Discussion for I-B.Sc Students Dated: 13-09-2021.



S.G.A. GOVERNMENT DEGREE COLLEGE

(Re-accredited by NAAC with 'A' Grade, Affiliated to Andhra University)

YELLAMANCHILI - 531055, ANDHRA PRADESH



Group Discussion on Applications of Nano-Science dated : 10-10-2021.



S.G.A. GOVERNMENT DEGREE COLLEGE

(Re-accredited by NAAC with 'A' Grade, Affiliated to Andhra University)

YELLAMANCHILI - 531055, ANDHRA PRADESH



Student Group Discussion on “super-Conductors”, “Raman Effect”, “Crystals” by III-B.Sc Students Dated: 26-11-2021.



5.1.2.(3) Life Skills (Yoga, Physical Fitness, Health and Hygiene)

Introduction:

‘Yoga’, it is a process of life which, every Indian inherited from ancestors of India as a part of Culture and heritage which now echoing worldwide being in practice due to its wide importance, usefulness both physical and mental leading to a spirituality. It is a non-religious activity. Yoga, the name came into limelight in recent years, and worldwide it is being observed on June 21st as International Yoga day from its inception 2015. Our Prime Minister Narendra Modi participated in Yoga demonstration along with thousands of Indians at Mysore palace on this day.

Yoga is an Art and Science of healthy living. It is a mystical discipline based on an enormously subtle science, which emphasizes on bringing harmony between mind and body. The all-inclusive approach of Yoga is well established and it brings harmony in all walks of life and thus, known for disease prevention, promotion of health and management of many lifestyle –related disorders.

In yoga different, different body postures performed for a fixed time, which gives physical health. Surya Namaskaras are most popular and this practice one alone gives good health to the people. In meditation, the mind concentrate on Atma or Light or Brahma, which gives mental health and increases energy levels and lifespan.

In Yoga, there are many Asanas such as

1. Padmasana
2. Vajrasana
3. Gomukhasana
4. Sarvangasana
5. Seershasana etc.,

In meditation many practicing methods are present such as

1. Pyramid Meditation
2. Mindfulness Meditation
3. Breath awareness Meditation
4. Transcendental Meditation
5. Pranic Healing Meditation

Aims and objectives of Yoga:

- 1. To make the students aware of Yoga and its importance.
- 2. To enhance patience, endurance to face any situation in life.
- 3. To make them healthy and wealthy with good practice of Yoga
- 4. To make good citizens
- 5. To make the stake-holders, pay attention and concentration on their studies.



S.G.A.GOVERNMENT DEGREE COLLEGE

(Re-accredited by NAAC with 'A' Grade, Affiliated to Andhra University)

YELLAMANCHILI - 531055, ANDHRA PRADESH



- 6. To improve personal hygiene.
- 7. To involve them in group activity, so that they improve communal harmony.
- 8. To taught them good communication.
- 9. To focus on Yoga's astangamarga through which everyone may be enlightened

ABSTRACT

S.NO.	Date	Name of the Activity	Name of Resource person	No. of students enrolled/ participated
1	21-06-2022	AsanasKriyas and Bandanas	M.Satyanarayana Lect.in English, diploma holder in Yoga and Dr. Chandra MouliHod Botany acted as Demonstrator	105
2.	19-02-2022	Surya namaskar's and Meditation	M. Srinu, PET	30
3	16-12-2021	Performed Asanas and fitness exercises	Dr.Chandra Mouli, Co-Ordinator Yoga	105
4.	30-11-2021	Performed Various Asanas and meditation	Smt. Padma Leela and Mr.Naga Raju, Ramachandra Mission, Viskahapatnam	108
5.	21-06-2019	Performed various yoga kriyas and Meditation	Mr. Prasad Physical Director, SGA Degree College, YLM	100
6.	21-06-2018	Various Asanas and Meditation	P.Srinivasa Rao Yoga Instructor Yellamanvhili	100
7.	21-06-2017	Surya Namaskar's and Meditation	Mr.Prasad Physical Director, SGA Degree College, YLM	110



S.G.A.GOVERNMENT DEGREE COLLEGE

(Re-accredited by NAAC with 'A' Grade, Affiliated to Andhra University)

YELLAMANCHILI - 531055, ANDHRA PRADESH



Circular

Date: 21-06-2017

This is to inform you that all the students as well all the teaching staff that our college is going to celebrate National Yoga Day on the eve of International Yoga Day, a call given by our beloved Prime Minister Narendra Modiji on 21st June at our Seminar Hall at 10:30 AM. You all are requested to attend with white uniform or any convenient dress and if possible please bring a yoga mat to perform yoga asanas and other related kriyas.

Your presence is highly demanded on this occasion as the class work suspended.

All the staff once again requested to make it a grand success. Together we can make it grand.

Yoga and Physical fitness

Principal
S.G.A.Govt.Degree College
YELLAMANCHILI - 531055
Visakhapatnam District.

Signature of the CO-Ordinator,



S.G.A.GOVERNMENT DEGREE COLLEGE

(Re-accredited by NAAC with 'A' Grade, Affiliated to Andhra University)

YELLAMANCHILI - 531055, ANDHRA PRADESH



Program: International Yoga Day

Date: 21-06-2017



Staff and students were participated in InternationalYoga day was conducted on 21-06-2017. Nearly 120 students were enrolled in this programme and all the enrolled students were actively participated and all the staff have also participated in this programme.



S.G.A.GOVERNMENT DEGREE COLLEGE

(Re-accredited by NAAC with 'A' Grade, Affiliated to Andhra University)

YELLAMANCHILI - 531055, ANDHRA PRADESH



STUDENTS ENROLLED AND PARTICIPATED IN YOGA AND MEDITATION 2017-18



S.G.A.GOVERNMENT DEGREE COLLEGE

(Re-accredited by NAAC with 'A' Grade, Affiliated to Andhra University)

YELLAMANCHILI - 531055, ANDHRA PRADESH



STUDENTS ENROLLED AND PARTICIPATED IN YOGA AND MEDITATION 2017-18

R. No	Name of the Student	Group	Signature of the student
	T.Devi	III B.A.	T. Devi
2	P.Purnachandra Rao	III B.A.	P. Purnachandra Rao
3	P.Syamala	III B.A.	P. Syamala
4	P.Bala Sai	III B.A.	P. Bala Sai
5	R.Upriya	III B.A.	R. Upriya
6	S.Sonia Rani	III B.A.	S. Sonia Rani
7	S.Yamini	III B.A.	S. Yamini
8	S.Jyothi	III B.A.	S. Jyothi
9	S.Bharathi	III B.A.	S. Bharathi
10	T.Rajesh	III B.A.	T. Rajesh
11	V.Ramanamma	III B.A.	V. RAMANAMMA
12	V.Parvathi	III B.A.	V. Parvathi
13	A.Vijaya	III B.A.	A. Vijaya
14	E.Ganga Bavani	III B.A.	E. Ganga Bavani
15	K.Hymamani	III B.A.	K. Hymamani
16	K.Lakshmi	III B.A.	K. Lakshmi
18	K.Satya Rao	III B.A.	K. Satya Rao
19	K.Appalanarasa	III B.A.	K. Appalanarasa
20	K.Anil Rajesh	III B.A.	K. Anil Rajesh
21	K.Mahalakshmi	III B.A.	K. Mahalakshmi
22	K.Nagamani	III B.A.	K. Nagamani
23	N.Lakshmi	III B.A.	N. Lakshmi
24	G.N.S Saihyanarayana	III B.Com	G.N.S Saihyanarayana
25	R.Venkata Lakshmi	III B.Com	R. Venkata Lakshmi
26	A.A.L.Poornima	III B.Com	A.A.L. Poornima
27	A.Sivaji	III B.Com	A. Sivaji
28	B.Nagendra Babu	III B.Com	B. Nagendra Babu
29	B.S.Bhavani	III B.Com	B. S. Bhavani
30	B.Ravikranth	III B.Com	B. Ravikranth
31	Ch.Apparao	III B.Com	Ch. Apparao
32	Ch.Raju	III B.Com	Ch. Raju
33	Ch.Prasad	III B.Com	Ch. Prasad
34	Ch.Tattayyalu	III B.Com	Ch. Tattayyalu
35	D.Gangadhar	III B.Com	D. Gangadhar
36	D.Naga Appala Raju	III B.Com	D. Naga Appala Raju
37	G.Siva	III B.Com	G. Siva
38	G.Saritha	III B.Com	G. Saritha
39	G.Maanga	III B.Com	G. Maanga
40	G.N.Venkatalakshmi	III B.Com	G.N. Venkatalakshmi
41	I. Sridevi	III B.Com	I. Sridevi
42	J.V.B.Kumar	III B.Com	J.V.B. Kumar
43	J.Gangadhar	III B.Com	J. Gangadhar
44	K.Naga Raju	III B.Com	K. Naga Raju
45	K.Nooka Raju	III B.Com	K. Nooka Raju
46	K.Aruna	III B.Com	K. Aruna
47	K.Durga Bhavani	III B.Com	K. Durga Bhavani



S.G.A.GOVERNMENT DEGREE COLLEGE

(Re-accredited by NAAC with 'A' Grade, Affiliated to Andhra University)

VELLAMANCHILI - 531055, ANDHRA PRADESH



S.G.A.GOVERNMENT DEGREE COLLEGE

(Re-accredited by NAAC with 'A' Grade, Affiliated to Andhra University)

VELLAMANCHILI - 531055, ANDHRA PRADESH



(H-18)

48	K.Rajesh	III B.Com	K. Rajesh
49	K.Bala Ganga	III B.Com	K. B. Ganga
50	K. Appala Raju	III B.Com	K. Appala Raju
51	K.Madhavi	III B.Com	K. Madhavi
52	A.Vamsi	III BSC	A. Vamsi
53	B.Pavani	III BSC	B. Pavani
54	B.Santhoshi	III BSC	B. Santhoshi
55	B.Venkata Lakshmi	III BSC	B. Venkata Lakshmi
56	B.Devi	III BSC	B. Devi
57	B.Sravani	III BSC	B. Sravani
58	C.Satya Chundini	III BSC	C. Satya Chundini
59	D.Ganesh	III BSC	D. Ganesh
60	D.Gangadhar	III BSC	D. Gangadhar
61	D.Sanyaso Rao	III BSC	D. Sanyaso Rao
62	E.Gangadhara	III BSC	E. Gangadhara
63	G.Bhuvaneshwar Rao	III BSC	G. Bhuvaneshwar Rao
64	G.Anu	III BSC	G. Anu
65	G.Nirmala Kumara	III BSC	G. Nirmala Kumara
66	K.Swathi	III BSC	K. Swathi
67	K.Indravathi	III BSC	K. Indravathi
68	K.Venkatesh	III BSC	K. Venkatesh
69	L.Sunitha	III BSC	L. Sunitha
70	M.Srivani	III BSC	M. Srivani
71	M.U.Leeja Kumara	III BSC	M. U. Leeja Kumara
73	M.Sektaru	III BSC	M. Sektaru
74	M.Sowjanya	III BSC	M. Sowjanya
75	M.Akshaya Kumara	III BSC	M. Akshaya Kumara
76	P.Chantamma	III BSC	P. Chantamma
77	P.Prasad	III BSC	P. Prasad
78	R.Ramesh	III BSC	R. Ramesh
79	S.Govind Suresh	III BSC	S. Govind Suresh
80	S.Devi	III BSC	S. Devi
81	S.Gayathri	III BSC	S. Gayathri
82	Shaik Raziya Bhanu	III BSC	S. Bhanu
83	S.Bhoeloka Naidu	III BSC	S. Bhoeloka Naidu
84	T.Chendrakala	III BSC	T. Chendrakala



S.G.A.GOVERNMENT DEGREE COLLEGE

(Re-accredited by NAAC with 'A' Grade, Affiliated to Andhra University)

VELLAMANCHILI - 531055, ANDHRA PRADESH



S.G.A.GOVERNMENT DEGREE COLLEGE

(Re-accredited by NAAC with 'A' Grade, Affiliated to Andhra University)

VELLAMANCHILI - 531055, ANDHRA PRADESH



(17-18)

85	T.Bhavani	III BSC	T. Bhavani
86	T.Nannji	III BSC	T. Nannji
87	V.Sarojini	III BSC	V. sarojini
88	Y.Uma	III BSC	Y. Uma
89	A.Hindumathi	III BSC	A. Hindumathi
90	A.Durga Bhavani	III BSC	A. Durga Bhavani
91	A.Kavitha	III BSC	A. Kavitha
92	B.Jyothi	III BSC	B. Jyothi
93	B.Maha Lakshmi	III BSC	B. Maha Lakshmi
94	B.A.N.Murthy	III BSC	B. A. N. Murthy
95	B.Jyothi Ramya	III BSC	B. Jyothi Ramya
96	Ch.Amaravathi	III BSC	Ch. Amravathi
97	G.Satya	III BSC	G. satya
98	G.Sri Lakshmi	III BSC	G. Sri Lakshmi
99	K.Kanchana	III BSC	K. Kanchana
100	K.Parvathi	III BSC	K. parvathi
101	K.Ganga Bhavani	III BSC	K. Ganga Bhavani
102	N.Uma Maheswari	III BSC	N. Uma Maheswari
103	N.Sireesha	III BSC	N. sireesha
104	O.Manikyam	III BSC	O. Manikyam
105	P.Uma	III BSC	P. Uma
106	P.Kusuma Kumara	III BSC	P. Kusuma Kumara
107	P.Kiranmayi	III BSC	P. Kiranmayi
108	R.Nagalakshmi	III BSC	R. nagalakshmi
109	S.Rama Devi	III BSC	S. Rama Devi
110	T.Nookaratnam	III BSC	T. Nookaratnam



S.G.A.GOVERNMENT DEGREE COLLEGE

(Re-accredited by NAAC with 'A' Grade, Affiliated to Andhra University)

YELLAMANCHILI - 531055, ANDHRA PRADESH



Circular

Date: 21-06-2018

This is to inform you that all the students as well all the teaching staff that our college is going to celebrate National Yoga Day on the eve of International Yoga Day, a call given by our beloved Prime Minister Narendra Modiji on 21st June at our Seminar Hall at 10:30 AM. You all are requested to attend with white uniform or any convenient dress and if possible please bring a yoga mat to perform yoga asanas and other related kriyas.

Your presence is highly demanded on this occasion as the class work suspended.

All the staff once again requested to make it a grand success. Together we can make it grand.

Signature of the CO-Ordinator,
Yoga and Meditation

Principal
S.G.A.Govt.Degree College
YELLAMANCHILI - 531055
Visakhapatnam District.



S.G.A.GOVERNMENT DEGREE COLLEGE

(Re-accredited by NAAC with 'A' Grade, Affiliated to Andhra University)

YELLAMANCHILI - 531055, ANDHRA PRADESH



Program: International Yoga Day Conducted on 21-06-2018



**Staff and students participated in International
Yoga day on 21-06-2018**



S.G.A.GOVERNMENT DEGREE COLLEGE

(Re-accredited by NAAC with 'A' Grade, Affiliated to Andhra University)

YELLAMANCHILI - 531055, ANDHRA PRADESH



LIST OF STUDENTS ENROLLED AND PARTICIPATED IN YOGA AND MEDITATION 2018-19



S.G.A.GOVERNMENT DEGREE COLLEGE

(Re-accredited by NAAC with 'A' Grade, Affiliated to Andhra University)

YELLAMANCHILI - 531055, ANDHRA PRADESH



LIST OF STUDENTS ENROLLED AND PARTICIPATED IN YOGA AND MEDITATION 2018-19

S. No	Name of the Student	Group	Signature of the student
1	K.Lokesh	III BA	K. Lokesh
2	P.Jaya Sri	III BA	P. Jaya Sri
3	N.Swathi	III BA	N. Swathi
4	Y. Jayalakshmi	III BA	Y. Jayalakshmi
5	Y. Bharathi	III BA	Y. Bharathi
6	CH.Sravni	III BA	CH. Sravani
7	K.Siva sankar	III BA	K. Siva Sankar
8	B.Radhika	III BA	B. Radhika
9	Y.Naga DURGA Prasad	III BA	Y. Naga Durga Prasad
10	S.Sandya Rani	III BA	S. Sandya Rani
11	A.Vasu	III BA	A. Vasu
12	K.Lakshmi Soujanya	III BA	K. Lakshmi Soujanya
13	V.Vasanta	III BA	V. Vasantha
14	K.Padmmini	III BA	K. Padmini
15	M.Nooka Ratnam	III BA	M. Nooka Ratnam
16	M.Brajesh	III BA	M. Brajesh
18	G.Prasad	III BA	G. Prasad
19	p.Jyothi	III BA	P. Jyothi
20	B.Chandra Sekhar	III BA	B. Chandra Sekhar
21	S. Bhagya lakshmi	III BA	S. Bhagya Lakshmi
22	Ch.Nagalakshmi	III B.Com	CH. Nagalakshmi
23	Dhuli Charan Raja	III B.Com	D. Charan Raja
24	Dhuli Sravani	III B.Com	D. Sravani
25	E.Narasimha Murthy	III B.Com	E. Narasimha Murthy
26	Gangalla Ramu	III B.Com	G. Ramu
27	Gude Naga Sai Pushpa	III B.Com	G. Naga Sai Pushpa
28	Gutala Devi	III B.Com	Gutala Devi
29	Jarajana Devi	III B.Com	J. Devi
30	Jerryothula Bharathi	III B.Com	J. Bharathi
31	Jerryothula Durga Prasad	III B.Com	J. Durga Prasad
32	Kambala Bala Ganga	III B.Com	K. Bala Ganga
33	Kandrakota Raju	III B.Com	K. Raju
34	Kandrakota Veeralakshmi	III B.Com	K. Veeralakshmi
35	Konnuri Shesu Babu	III B.Com	K. Shesu Babu
36	Kurri Indu	III B.Com	K. Indu
37	Kurri Sai Thulasi	III B.Com	K. Sai Thulasi
38	Kasimkota Mahalakshmi	III B.Com	K. Mahalakshmi
39	Kottumuri Murali	III B.Com	K. Murali
40	Kolli Naga Kumar	III B.Com	K. Naga Kumar
41	Koppiji Sathyanarana	III B.Com	K. Sathyanarana
42	K.Sathya Durga Prasad	III B.Com	K. Sathya Durga Prasad



S.G.A.GOVERNMENT DEGREE COLLEGE

(Re-accredited by NAAC with 'A' Grade, Affiliated to Andhra University)

YELLAMANCHILI - 531055, ANDHRA PRADESH



S.G.A.GOVERNMENT DEGREE COLLEGE

(Re-accredited by NAAC with 'A' Grade, Affiliated to Andhra University)

YELLAMANCHILI - 531055, ANDHRA PRADESH



(18)

43	Karandasu Kasu	III H.Com	
44	Karupate Nagalakshmi	II Bcom	K. Nagalakshmi
45	Laveti Krupa Rani	II Bcom	L. Laveti Rani
46	Mandapati Manikyam	II Bcom	M. Manikyam
47	Mantini Jyothi	II Bcom	M. Jyothi
48	Mylapalli Rama Devi	II Bcom	M. Rama Devi
49	Nunna Kasi	II Bcom	N. Kasi
50	Pakurtti Nagaratnam	III BSC	P. Nagaratnam
51	Pinapala Hyma	III BSC	Pinapala Hyma
52	D.Rajya Lakshmi	III BSC	D. Rajya Lakshmi
53	D.Janaki	III BSC	D. Janaki
54	G.Sai durga Prasad	III BSC	G. Sai durga Prasad
55	G.Murali Krishna	III BSC	G. murali krishna
56	G.Sylu Kumar	III BSC	G. Sylu Kumar
57	G.Gowri Parvathi	III BSC	G. Gowri parvathi
58	G.Naga Lakshmi	III BSC	G. Naga lakshmi
59	J.Ganesh	III BSC	J. Ganesh
60	J.Sukanya	III BSC	J. sukanya
61	J.Sivaji	III BSC	J. Sivaji
62	J.Varma	III BSC	J. varma
63	K.Bhavani	III BSC	K. Bhavani
64	K.Shirisha	III BSC	k. shirisha
65	K.R.N.Apparao	III BSC	K.R.N. Apparao
66	K.N.Apparao	III BSC	K.N. APPARAO
67	K.Ramya	III BSC	K. Ramya
68	K.Sai	III BSC	K. Sai
69	K.Rama Satya	III BSC	K. Rama Satya
70	K.Srinu	III BSC	K. Srinu
71	M.Srinu	III BSC	M. Srinu
73	M.Ramana	III BSC	M. Ramana
74	M.Srinu	III BSC	M. Srinu
75	P.N.Sai Kumar	III BSC	P N Sai Kumar
76	R.Sridhar	III BSC	R. Sridhar
77	R.Anil	III BSC	R. Anil
78	S.Asha	III BSC	S. Asha



S.G.A.GOVERNMENT DEGREE COLLEGE

(Re-accredited by NAAC with 'A' Grade, Affiliated to Andhra University)

YELLAMANCHILI - 531055, ANDHRA PRADESH



S.G.A.GOVERNMENT DEGREE COLLEGE

(Re-accredited by NAAC with 'A' Grade, Affiliated to Andhra University)

YELLAMANCHILI - 531055, ANDHRA PRADESH



(18-19)

79	S.Venkata Ramana	III BSC	S. Venkata Ramana
80	T.Geeta Satya	III BSC	T. Geeta Satya
81	V.Ganesh	III BSC	V. Ganesh
82	Y.Pydi Raju	III BSC	Y. Pydi Raju
83	Y.Naga Lakshmi	III BSC	Y. Naga Lakshmi
84	Y.Swathi Lakshmi	III BSC	Y. Swathi Lakshmi
85	A.Yamini	III BSC	A. Yamini
86	B.Nagaraju	III BSC	B. Nagaraju
87	B.Shirisha	III BSC	B. Shirisha
88	B.Hyma	III BSC	B. Hyma
89	B.V.Bhavani	III BSC	B.V. Bhavani
90	Ch.Naresh Kumar	III BSC	Ch. Naresh Kumar
91	Ch.Durga Prasad	III BSC	Ch. Durga Prasad
92	D.Nookaratnam	III BSC	D. NOOKARATHNAM
93	D.B.Ramadevi	III BSC	D.B. Ramadevi
94	G.Gowthami	III BSC	G. Gowthami
95	G.Vimala	III BSC	G. Vimala
96	G.Pournima	III BSC	G. Pournima
97	G.Durga Sravani	III BSC	G. Durga Sravani
98	J.Rani	III BSC	J. Rani
99	K.Akhila	III BSC	K. Akhila
100	K.Madhuri	III BSC	K. Madhuri



S.G.A.GOVERNMENT DEGREE COLLEGE

(Re-accredited by NAAC with 'A' Grade, Affiliated to Andhra University)

YELLAMANCHILI - 531055, ANDHRA PRADESH



Circular

Date: 21-06-2019

This is to inform you that all the students as well all the teaching staff that our college is going to celebrate National Yoga Day on the eve of International Yoga Day, a call given by our beloved Prime Minister Narendra Modiji on 21st June at our Seminar Hall at 10:30 AM. You all are requested to attend with white uniform or any convenient dress and if possible please bring a yoga mat to perform yoga asanas and other related kriyas.

Your presence is highly demanded on this occasion as the class work suspended.

All the staff once again requested to make it a grand success. Together we can make it grand.

Yoga and Physical Fitness

Principal
S.G.A.Govt.Degree College
YELLAMANCHILI - 531055
Visakhapatnam District.

ProgrammeCO-Ordinator,



S.G.A.GOVERNMENT DEGREE COLLEGE

(Re-accredited by NAAC with 'A' Grade, Affiliated to Andhra University)

YELLAMANCHILI - 531055, ANDHRA PRADESH



Program: International Yoga Day

Date: 21-06-2019



**Staff and students participated in International
Yoga day conducted on 21-06-2019**



S.G.A.GOVERNMENT DEGREE COLLEGE

(Re-accredited by NAAC with 'A' Grade, Affiliated to Andhra University)

VELLAMANCHILI - 531055, ANDHRA PRADESH



LIST OF STUDENTS ENROLLED AND PARTICIPATED IN YOGA AND MEDITATION 2019-20



S.G.A.GOVERNMENT DEGREE COLLEGE

(Re-accredited by NAAC with 'A' Grade, Affiliated to Andhra University)

VELLAMANCHILI - 531055, ANDHRA PRADESH



LIST OF STUDENTS ENROLLED AND PARTICIPATED IN YOGA AND MEDITATION 2019-20

S. No	Name of the Student	Group	Signature of the student
1	A.J.Durga Prasad	I B.A.	A.J. Durga Prasad
2	G.Lavanya	I B.A.	G. Lavanya
3	P.Sravani	I B.A.	P. Sravani
4	T.Lakshmi	I B.A.	T. Lakshmi
5	J.Ramu	I B.A.	J. Ramu
6	B.Bhanu Praksh	I B.A.	B. Bhanu praksh
7	G.Manasa	I B.A.	G. Manasa
8	M.Kamakshi Devi	I B.A.	M. Kamakshi Devi
9	G.Durga Prasad	I B.A.	G. Durga prasad
10	M.Teja	I B.A.	M. Teja
11	L. Trinadh	I B.A.	L. Trinadh
12	P.Urmila	I B.A.	P. Urmila
13	G.Naveen	I B.A.	G. Naveen
14	D.Bharati	I B.A.	D. Bharathi
15	G.Naga Jyothi	I B.A.	G. Naga Jyothi
16	A.Sowjanya	I B.A.	A. Sowjanya
18	D.Durga Prasad	I B.A.	D. Durga prasad
19	K.Lavanya	I B.A.	K. Lavanya
20	K.Indhumathi	I B.A.	K. Indhumathi
21	A.Konda Babu	I B.A.	A. Konda Babu
22	B.Gouri Devi	I B.A.	B. Gouri Devi
23	C.Harshavardhan	I B.A.	C. Harshavardhan
24	D.Av.V.S.N.Murthy	I B.A.	D. Av. V. S. N. Murthy
25	Korni Ammaji	III Bcom	Korni Ammaji
26	Mollu Vasantha	III Bcom	M. Vasantha
27	Mudi Kameswari	III Bcom	M. Kameswari
28	Muntha Divya	III Bcom	M. Divya
29	Murthy Ravi	III Bcom	M. Ravi
30	Mylapalli Prasad	III Bcom	M. Prasad
31	Nadupudi Vennela	III Bcom	N. Vennela
32	N.Koteswarao	III Bcom	N. Koteswarao
33	Penta Priyanka Rani	III Bcom	P. Priyanka Rani
34	Petkamsetti Shivani	III Bcom	P. Shivani
35	Pilla Ramya	III Bcom	Pilla Ramya
36	Pilla Jagadeesh	III Bcom	P. Jagadeesh
37	Polavarapu Lavanya	III Bcom	P. Lavanya
38	Potla Bharathi	III Bcom	P. Bharathi
39	Ramoji Jyothi	III Bcom	R. Jyothi
40	R.Gana Lakshmi	III Bcom	R. Gana Lakshmi
41	Ruthala Lavanya	III Bcom	R. Lavanya
42	Ruthala Lavanya	III Bcom	R. Lavanya
43	Sana Naga Devi	III Bcom	Sana Naga Devi



S.G.A. GOVERNMENT DEGREE COLLEGE

(Re-accredited by NAAC with 'A' Grade, Affiliated to Andhra University)

VELLAMANCHILI - 531055, ANDHRA PRADESH



S.G.A. GOVERNMENT DEGREE COLLEGE

(Re-accredited by NAAC with 'A' Grade, Affiliated to Andhra University)

VELLAMANCHILI - 531055, ANDHRA PRADESH



(19-20)

44	Somireddy Balamani	III Bcom	S. Balamani
45	Sundarapu Sathya	III Bcom	S. Sathya
46	Sunkara Lavanya	III Bcom	S. Lavanya
47	Tadepalli Leela Kumari	III Bcom	T. Leela Kumari
48	Vadhalapudi Bharathi	III Bcom	V. Bharathi
49	Vamda Venkata Lakshmi Sravani	III Bcom	V. Venkata Lakshmi Sravani
50	Vegi Dhivya	III Bcom	Vegi Dhivya
51	Vunda Hari Babu	III Bcom	V. Hari Babu
52	Y. Bhagya Lakshmi	III Bcom	Y. Bhagya Lakshmi
53	A. Anuradha	III Bcom	A. Anuradha
54	B. Glori Stone	III Bcom	B. Glori Stone
55	Ch. Poorna Vigneshwari	III Bcom	Ch. Poorna Vigneshwari
56	D. Raja Kumari	III Bcom	D. Raja Kumari
57	E. Shivaji	III Bcom	E. Shivaji
58	G. Mukesh	III Bcom	G. Mukesh
59	G. Giri	III Bcom	G. Giri
60	I. Jagadesh	III Bcom	I. Jagadesh
61	K. Jyothi	III Bcom	K. Jyothi
62	K. Pavan Sai	III Bcom	K. Pavan Sai
63	K. Satya Veni	III Bcom	K. Venkatesh
64	K. Venkatesh	III Bcom	K. Venkatesh
65	K. Naga Lakshmi	III Bcom	K. Naga Lakshmi
66	L. Neerisha	III Bcom	L. Neerisha
67	M. Suryamani	III Bcom	M. Suryamani
68	M. Prasad	III Bcom	M. Prasad
69	M. Sai	III Bcom	M. Sai
70	N. Tulasi	III Bcom	N. Tulasi
71	N. Sai Lakshmi	III Bcom	N. Sai Lakshmi
73	O. Manga	III Bcom	O. Manga
74	O. Shivaji	III Bcom	O. Shivaji
75	P. Vara Lakshmi	III Bcom	P. Vara Lakshmi
76	P. Neeraja	III Bcom	P. Neeraja
77	P. Venkats Lakshmi	III Bcom	P. Venkats Lakshmi
78	P. Bangra Raju	III Bcom	P. Bangra Raju
79	P. Jagatha	III Bcom	P. Jagatha
80	G. Sai Durga Prasad	III BSC	G. Sai Durga Prasad
81	G. Muruli Krishna	III BSC	G. Muruli Krishna
82	G. Sylu Kumar	III BSC	G. Sylu Kumar
83	G. Gowri Parvathi	III BSC	G. Gowri Parvathi
84	G. Naga Lakshmi	III BSC	G. Naga Lakshmi
85	J. Ganesh	III BSC	J. Ganesh
86	J. Sukanya	III BSC	J. Sukanya
87	J. Sivaji	III BSC	J. Sivaji



S.G.A.GOVERNMENT DEGREE COLLEGE

(Re-accredited by NAAC with 'A' Grade, Affiliated to Andhra University)

YELLAMANCHILI - 531055, ANDHRA PRADESH



S.G.A.GOVERNMENT DEGREE COLLEGE

(Re-accredited by NAAC with 'A' Grade, Affiliated to Andhra University)

YELLAMANCHILI - 531055, ANDHRA PRADESH



(9-20)

88	J.Varna	III BSC	J.Varna.
89	K.Bhavani	III BSC	K.Bhavani
90	K.Shirisha	III BSC	K. Shirisha,
91	K.R.N.Apparao	III BSC	K.R.N.Apparao
92	K.N.Apparao	III BSC	K.N.Apparao
93	K.Ramya	III BSC	K. Ramya
94	K.Sai	III BSC	K.Sai
95	K.Rama Satya	III BSC	K. Rama satya
96	K.Srinu	III BSC	K.Srinu
97	M.Srinu	III BSC	M. Srinu.
98	M.Ramana	III BSC	M. Ramana
99	M.Srinu	III BSC	m. Srinu.
100	P.N.Sai Kumar	III BSC	P.N.Sai Kumar.



S.G.A.GOVERNMENT DEGREE COLLEGE

(Re-accredited by NAAC with 'A' Grade, Affiliated to Andhra University)

YELLAMANCHILI - 531055, ANDHRA PRADESH



Circular

Date: 30-11-2021

This is to inform you that all the students and all the teaching staff that our college is going to organise Yoga Class by the resource persons Smt. Padma Leela and Mr. Naga Raju of Ramachandra Mission, Visakhaptanam in our Seminar Hall at 11 AM. You all are requested to attend with white uniform or any convenient dress and if possible please bring a yoga mat to perform yoga asanas and other related kriyas.

Your presence is highly demanded on this occasion as the class work suspended.

O-Ordinator,
Yoga and Physical Fitness

ProgrammeC

Principal
S.G.A. Govt. Degree College
Yellamanchili-531 055
Anakapalli District. (A.P.)



S.G.A.GOVERNMENT DEGREE COLLEGE

(Re-accredited by NAAC with 'A' Grade, Affiliated to Andhra University)

YELLAMANCHILI - 531055, ANDHRA PRADESH



NSS UNITS OF GDC YELLAMANCHILI ORGANIZED A PROGRAMME ON YOGA & MEDITATION FOR THE STUDENTSON 30.11.2021



Smt. Padma Leela and Mr. Naga Raju yoga guru”sand experts in meditation from Ramachandra Mission,Visakhapatnam has created awareness and trained the students in doing yoga and meditation.

Dr. P. Chandra Sekher, Pricipal Dr.B.ChadraMouli, lecturer in Botany and Sri G.Satyanarayana, Lecturer in English, Diploma in Yoga, have enlightened the students about yoga and meditation. More than 100 students and 15 lecturers have actively participated in the programme and they felt happy in doing yoga and decided to continue it to lead a better lifestyle.



S.G.A.GOVERNMENT DEGREE COLLEGE

(Re-accredited by NAAC with 'A' Grade, Affiliated to Andhra University)

YELLAMANCHILI - 531055, ANDHRA PRADESH



LIST OF STUDENTS ENROLLED AND PARTICIPATED IN YOGA AND MEDITATION 2020-21



S.G.A.GOVERNMENT DEGREE COLLEGE

(Re-accredited by NAAC with 'A' Grade, Affiliated to Andhra University)

YELLAMANCHILI - 531055, ANDHRA PRADESH



(20-21)

LIST OF STUDENTS ENROLLED AND PARTICIPATED IN YOGA AND MEDITATION 2020-21

S. No	Name of the Student	Group	Signature of the student
1	Arjilli Ratha	III Year	Arjilli Ratha
2	Avupati Syamaladevi	III Year	A. Syamala Devi
3	Bheemuni Purni	III Year	Bheemuni purni
4	Bondi Chandini	III Year	B. Chandina
5	Bondi Satyavathi	III Year	B. Satyavathi
6	B. Tulasi Naga Lakshmi	III Year	B. Tulase naga lakshmi
7	Dallapalli Anmaji	III Year	D. Anmaji
8	Gangireddu Janaki	III Year	G. Janaki
9	Gele Gayathri	III Year	G. Gayathri
10	Jagu Jayasree	III Year	Jagu Jayasree
11	Janapala Kumari	III Year	J. Kumari
12	Kakkala Raviteja	III Year	K. Raviteja
13	Koorna Sirisha	III Year	K. Sirisha
14	Koyilada Bharathi	III Year	Koyilada Bharathi
15	Kuppina Divya	III Year	K. Divya
16	K. Durgaprasad	III Year	K. Durgaprasad
18	Mariseti Usha	III Year	M. Usha
19	Molli Bhavani	III Year	Molli Bhavani
20	Muppina Vasantha	III Year	Molli Vasantha
21	P. Venkata Lakshmi	III Year	P. Venkata Lakshmi
22	Pikki Kameswari	III Year	P. Kameswari
23	Pothu Suryakala	III Year	Pothu Suryakala
24	Pragada Revathi	III Year	P. Revathi
25	Puliga Neelavathi	III Year	P. Neelavathi
26	Pure Satyaveni	III Year	P. Satyaveni
27	Rajara Syamala	III Year	R. Syamala
28	Rayi Sirisha	III Year	Rayi Sirisha
29	Rebaka Sandhya	III Year	R. Sandhya
30	Reddy Madhavi	III Year	K. Madhavi
31	Sivalanka Neelima	III Year	S. Neelima
32	Siyyadi Hemalata	III Year	Siyyadi Hemalata



S.G.A.GOVERNMENT DEGREE COLLEGE

(Re-accredited by NAAC with 'A' Grade, Affiliated to Andhra University)

YELLAMANCHILI - 531055, ANDHRA PRADESH



S.G.A.GOVERNMENT DEGREE COLLEGE

(Re-accredited by NAAC with 'A' Grade, Affiliated to Andhra University)

YELLAMANCHILI - 531055, ANDHRA PRADESH



20-21

33	T. Bala Nookeswari	III Year	T. Bala Nookeswari
34	Terapelli Sarikarnao	III Year	T. Sarikarnao
35	Vegi Prathyusha	III Year	V. Prathyusha
36	Velaga Pavani	III Year	V. Pavani
37	Viyapu Padma	III Year	V. Padma
38	Viyapu Sai Kumari	III Year	V. Sai Kumari
39	V. Venkatalakshmi	III Year	V. Venkatalakshmi
40	Yajjala Prasanthi	III Year	Y. Prasanthi
41	Adduri Ramya	II Year	A. Ramya
42	Baddi Sravani	II Year	B. Sravani
43	Chirikela Gayathri	II Year	C. Gayathri
44	Chokka Chinnari	II Year	C.H. Chinnari
45	Dadi Dhamani	II Year	Dadi Dhamani
46	G. Durga Bhavani	II Year	G. Durga Bhavani
47	Gosala Kavya	II Year	G. KAVYA
48	Gosala Sandhya	II Year	G. Sandhya
49	Gumpina Pavani	II Year	G. Pavani
50	Javvadi Jyothi	II Year	J. Jyothi
51	Kaligaita Bhargavi	II Year	K. Bhargavi
52	K. Sujatha	II Year	K. Sujatha
53	K. Uma Maheswari	II Year	K. Uma Maheswari
54	K. P Sai Chandrika	II Year	K. P Sai Chandrika
55	K.Durga Bhavani	II Year	K. mahini Lakshmi
56	K. Mohini Lakshmi	II Year	K. Mohini Lakshmi
57	Karri Syamala	II Year	K. Syamala
58	Koda Aruna	II Year	K. Aruna
59	Marapureddi Sravani	II Year	M. Sravani
60	Mookulla Sailaja	II Year	M. Sailaja
61	Mylapalli Venkatesh	II Year	M. Venkatesh
62	Nammi Jayasri	II Year	N. Jayasri
63	Nandavarapu Rohini	II Year	P. Bhavani
64	Palla Bhavani	II Year	P. Bhavani
65	Pikki Sivarani	II Year	P. Sivarani
66	Pitla Bharathi	II Year	P. Bharathi
67	Rayavarapu Lavanya	II Year	R. Lavanya
68	Rekha Devi	II Year	R. Devi
69	Ruthala Bhavani	II Year	R. Bhavani
70	T. Vasanthakumari	II Year	T. Vasanthakumari
71	V. Varaprasad	II Year	V. Varaprasad
72	Vasapalli Gowthami	II Year	V. Gowthami



S.G.A.GOVERNMENT DEGREE COLLEGE

(Re-accredited by NAAC with 'A' Grade, Affiliated to Andhra University)

VELLAMANCHILI - 531055, ANDHRA PRADESH



S.G.A.GOVERNMENT DEGREE COLLEGE

(Re-accredited by NAAC with 'A' Grade, Affiliated to Andhra University)

VELLAMANCHILI - 531055, ANDHRA PRADESH



10-11

74	Vasipilli Chitti	II Year	V. Chitti
75	Yellapu Anootha	II Year	Y. Anootha
76	Yeripalli Poorna	II Year	Y. Poorna
77	A. Anuradha	I Year	A. Anuradha
78	Amalakanti Satya	I Year	A. Satya
79	Arjilli Ammaji	I Year	A. Ammaji
80	Chitti Devika	I Year	C. Devika
81	Devani Divya	I Year	D. Divya
82	Erigila Vandana	I Year	E. Vandana
83	Gorinta Meenakshi	I Year	G. Meenakshi
84	Guddati Usha Rani	I Year	G. Usha Rani
85	Kalla Pushpolakshmi	I Year	K. Pushpolakshmi
86	A.SAI SANDHYA	I B.COM	A. Sai Sandhya
87	BHEMALATHARUPASUSHMA	I B.COM	B. Hemalatha Rupasushma
88	B.VIJAYA	I B.COM	B. Vijaya
89	CHKANAMAHALAKSHMI	I B.COM	Ch. Kanamahalakshmi
90	CH NOKKARATNAM	I B.COM	Ch. Nookaratnam
91	CHRAJU	I B.COM	CH. RAJU
92	D.YAMUNA	I B.COM	D. Yamuna
93	D. SUJATHA	I B.COM	D. Sujatha
94	E.YASU BABU	I B.COM	E. Yasu Babu
95	E.RADHIKA	I B.COM	E. Radhika
96	G.SURYA LAKSHMI	I B.COM	G. Surya Lakshmi
97	G.NAGA LAKSHMI	I B.COM	G. Naga Lakshmi
98	K.NAGA MANI	I B.COM	K. Naga Mani
99	K.DURGA PRASAD	I B.COM	K. Durga Prasad
100	K.RAMYA	I B.COM	K. Ramya
101	K.SUDHA	I B.COM	K. Sudha
102	K.SUNIL	I B.COM	K. Sunil
103	RAJI HARIKA	III B.COM	R. Harika
104	JAMI KRISHNA	III B.COM	J. Krishna
105	JUTHUKA KAVYA	III B.COM	J. Kavi Kavi
106	KANTAMREDDI MANIKUMARI	III B.COM	K. Kantamreddi Manikumar
107	KARANAM MAHESH	III B.COM	K. Mahesh
108	KARNI DIVYA	III B.COM	KARNI DIVYA



S.G.A.GOVERNMENT DEGREE COLLEGE

(Re-accredited by NAAC with 'A' Grade, Affiliated to Andhra University)

YELLAMANCHILI - 531055, ANDHRA PRADESH



Circular

Date: 16-12-2021

This is to inform you that all the students and all the teaching staff that our college is going to organise Yoga Class by Yoga CO-Ordinator B.ChandraMouli in our Seminar Hall at 11 AM. You all are requested to attend with white uniform or any convenient dress and if possible please bring a yoga mat to perform yoga asanas and other related kriyas.

Your presence is highly demanded on this occasion as the class work suspended.

Programme CO-Ordinator,
Yoga and Physical Fitness

Principal
S.G.A. Govt. Degree College
Yellamanchili-531 055
Anakapalli District. (A.P.)



S.G.A.GOVERNMENT DEGREE COLLEGE

(Re-accredited by NAAC with 'A' Grade, Affiliated to Andhra University)

YELLAMANCHILI - 531055, ANDHRA PRADESH



Extension activity, 2021-22

Activity: Practice Session of Yoga and Meditation Date: 16-12-2021



Dr. B. Chandramouli, Lecturer in Botany Explaining the importance of Yoga & Meditation



Staff and Students in the practice session of Meditation



S.G.A.GOVERNMENT DEGREE COLLEGE

(Re-accredited by NAAC with 'A' Grade, Affiliated to Andhra University)

YELLAMANCHILI - 531055, ANDHRA PRADESH



LIST OF STUDENTS ENROLLED AND PARTICIPATED IN YOGA AND MEDITATION 2020-21



S.G.A.GOVERNMENT DEGREE COLLEGE

(Re-accredited by NAAC with 'A' Grade, Affiliated to Andhra University)

YELLAMANCHILI - 531055, ANDHRA PRADESH

Staff and Students in the practice session of Meditation



10-21

LIST OF STUDENTS ENROLLED AND PARTICIPATED IN YOGA AND MEDITATION 2020-21

S. No	Name of the Student	Group	Signature of the student
1	Arjilli Ammaji	II BSC	A. Ammaji
2	Chitti Devika	II BSC	Ch. Devika
3	Devara Divya	II BSC	D. Divya
4	Erigila Vandana	II BSC	C. Vandana
5	Gorinta Meenakshi	II BSC	G. Meenakshi
6	Guddati Usha Rani	II BSC	G. Usha Rani
7	Kalla Pushpalakshmi	II BSC	K. Pushpa Lakshmi
8	Kantamreddy Asha	II BSC	K. Asha
9	Karri Viswanadham	II BSC	K. Viswanadham
10	Kolanti Anusha	II BSC	K. Anusha
11	M. Bhagyalakshmi	II BSC	M. Bhagy Lakshmi
12	Mogili Bhargavi	II BSC	M. Bhargavi
13	Moora Ratna Kumari	II BSC	M. Ratna Kumari
14	Ommi Kumari	II BSC	O. Kumari
15	Padala Triveni	II BSC	P. Triveni
16	Pedapudi Latha	II BSC	P. Latha
18	Pudi Kavya	II BSC	P. Kavya
19	Rajeswari Yanda	II BSC	Y. Rajeswari
20	Rangala Navya	II BSC	R. Navya
21	Reddi Daiva Madhuri	II BSC	R. Daiva madhuri
22	R. Venkatalakshmi	II BSC	R. Venkata Lakshmi
23	Shaik Rahim Tuneesha	II BSC	S. Rahim Tuneesha
24	Sony Gudala	II BSC	S. Sony
25	Telu Surya Lakshmi	II BSC	T. Surya Lakshmi
26	Th. Mounika Devi	II BSC	T. Mounika Devi
27	B. Sukanya	I BSC	B. Sukanya
28	B. Nookaratnam	I BSC	B. Nookaratnam
29	B. Tejasvi	I BSC	B. Tejasvi
30	B. Leela Praveena	I BSC	B. Leela praveena
31	B. Divya Krupa	I BSC	B. Divya Krupa
32	B. Lavanya	I BSC	B. Lavanya
33	Ch. Swathi	I BSC	Ch. Swathi
34	Ch. Mokshasri	I BSC	Ch. Mokshasri
35	D. Sivaji	I BSC	D. Sivaji
36	D. Nissi Alekhya	I BSC	D. Nissi Alekhya



S.G.A.GOVERNMENT DEGREE COLLEGE

(Re-accredited by NAAC with 'A' Grade, Affiliated to Andhra University)

VELLAMANCHILI - 531055, ANDHRA PRADESH



S.G.A.GOVERNMENT DEGREE COLLEGE

(Re-accredited by NAAC with 'A' Grade, Affiliated to Andhra University)

VELLAMANCHILI - 531055, ANDHRA PRADESH



20-21

37	E.Hema Varaha Durga	I BSC	E. Hema Varaha Durga
38	G.Emmi Vinolisi	I BSC	G. Emmi Vinolisi
39	G.Dhikshitha	I BSC	G. Dhikshitha
40	G.Kirankumar	I BSC	G. Kirankumar
41	G.Rani	I BSC	G. Rani
42	J.Sirdhu	I BSC	J. Sirdhu
43	K. Vasantha	I BSC	K. Vasantha
44	K.Lakshmi	I BSC	K. Lakshmi
45	K.Loriya	I BSC	K. Loriya
46	K.Mounika	I BSC	K. Mounika
47	K.Kumari Sreelakshmi	I BSC	K. Kumari Sreelakshmi
48	Kdivya	I BSC	K. Divya
49	L. Yasawini	I BSC	L. Yasawini
50	M.Devi	I BSC	M. Devi
51	M.Nagalakshmi	I BSC	M. Nagalakshmi
52	M.Pushpalatha	I BSC	M. Pushpalatha
53	M.Sravani Sai	I BSC	M. Sravani Sai
54	M. Siva Sravani	I BSC	M. Siva Sravani
55	M. Navitha	I BSC	M. Navitha
56	P.Pavani	I BSC	P. Pavani
57	P.Ratna Malathi Naveena	I BSC	P. Ratna Malathi Naveena
58	S.Divya	I BSC	S. Divya
59	T.Lohitha Sri	I BSC	T. Lohitha Sri
60	V.Sai	I BSC	V. Sai
61	V.Vineel	I BSC	V. Vineel
62	V.Jayasri	I BSC	V. Jayasri
63	V.Tulasi	I BSC	V. Tulasi
64	V.Uma Maheswari	I BSC	V. Uma Maheswari
65	N.Lakshmi Ganesh	II Bcom	N. Lakshmi Ganesh
66	P.Ganesh	II Bcom	P. Ganesh
67	P.Suryakala	II Bcom	P. Suryakala
68	P.Bhavani	II Bcom	P. Bhavani
69	P.Preetham	II Bcom	P. Preetham
70	P.Sukanya	II Bcom	P. Sukanya
71	P.Venkata Lakshmi	II Bcom	P. Venkata Lakshmi
73	R.Varalakshmi	II Bcom	R. Varalakshmi
74	S.Hymavathi	II Bcom	S. Hymavathi
75	S.Yakub Raju	II Bcom	S. Yakub Raju
76	T.Leela	II Bcom	T. Leela
77	U.Naveen	II Bcom	U. Naveen
78	U.Mayuri	II Bcom	U. Mayuri
79	G.Ganesh	III BSC	G. Ganesh
80	G.Sirisha Rani	III BSC	G. Sirisha Rani
81	G.Hari Babu	III BSC	G. Hari Babu
82	K.Mahesh	III BSC	K. Mahesh
83	K.Appalaraju	III BSC	K. Appalaraju
84	K. Chinnari	III BSC	K. Chinnari



International Yoga Day celebrations were organised in

SGA GDC Yellamanchili on 21-06-2022

The Programme Report:

Yoga day celebrated in a great befitting manner. Our college has two yoga diploma holders from Andhra University one is our college Physical Director Dr.Polireddy and the other Sri G. Satyanarayana, lecturer in English. On this day all the students were gathered in college seminar hall along with other teaching staff. Our Principal Dr. Chandrasekhar presided over the gathering and he addressed the students. In his speech he remarked the importance of Yoga and its importance, how it came into prominence. There after teaching staff also spoke about it. Mr. Satyanarayana lecturer in English acted as resource person and Dr. B. Chandramouli demonstrated acts of Yoga like Asanas, kriyas, Bhandanas.

Mr. Satyanarayana explained the following:

- | | |
|---------------|-----------------|
| 1. Yamas | : abstinences |
| 2. Niyama | : Observances |
| 3. Asana | : Postures |
| 4. Pranayama | : Breathing |
| 5. Prathahara | : Withdrawal |
| 6. Dharana | : Concentration |
| 7. Dhyna | : Meditation |
| 8. Samadhi | : Absorption |

After this explanation, he directed the pupil to do some warm-ups followed by postures in three states i.e., standing, sitting and lie-down.

In standing postures Tada asana, TiryakaTadaana, Kati Chakrasana, Hasta Utthanasana, AkaranaDhanrasana, Tiryakakatichakrasana, Meru Prishthasana, Utthansana, Trikonasana etc.,

In Sitting postures: Patchimothasana, Padmasana, Vajrasana, Kukkutasana, Ardhamathyasana, etc.,

Lay-down postures: Savasana, Bhujangasana, Halasana, Sarvangasana, Chakrasana, Sarpasana,

Apart from the above some balancing asanas also demonstrated and performed by the students.

After that Pranayama, the breathing exercise was performed and all the students paid interest as they learned through the description given by the resource person that it will help them in their studies to improve concentration.

The resource person G. Satyanarayana appreciated one of the female student who performed well in all asanas and awarded prize money. He also appreciated Dr.Chandramouli for his commitment in performing and guiding the students.



International Yoga Day Celebrations

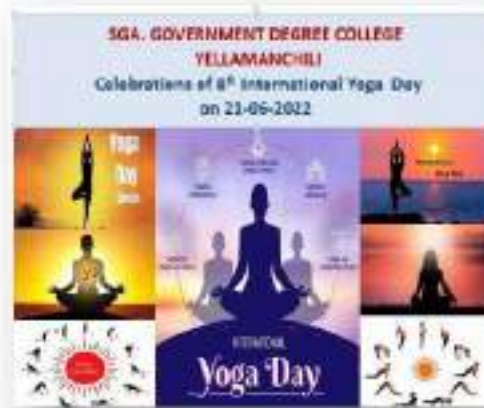

International Yoga Day Celebrations were held at seminar hall on 21-06-2022. Dr P Chandrasekhar along with staff and students were actively participated. Together all were practiced some popular yoga asanas.



**Dr B Chandramouli, Lecturer in Botany has demonstrated
the various yoga asanas to the students during
International Yoga Day Celebrations**



Departmental Activities



S.G.A.GOVERNMENT DEGREE COLLEGE

(Re-accredited by NAAC with 'A' Grade, Affiliated to Andhra University)

YELLAMANCHILI - 531055, ANDHRA PRADESH



LIST OF STUDENTS ENROLLED AND PARTICIPATED IN YOGA AND MEDITATION 2021-22



S.G.A.GOVERNMENT DEGREE COLLEGE

(Re-accredited by NAAC with 'A' Grade, Affiliated to Andhra University)

YELLAMANCHILI - 531055, ANDHRA PRADESH



LIST OF STUDENTS ENROLLED AND PARTICIPATED IN YOGA AND MEDITATION 2021-22

S. No	Name of the Student	Group	Signature of the student
1	Arjilli Amraji	II BSC	A. Amraji
2	Chitti Devika	II BSC	ch. Devika
3	Devara Divya	II BSC	Devara Divya.
4	Erigila Vandana	II BSC	E. Vandana
5	Gorinta Meenakshi	II BSC	Or. Meenakshi
6	Guddati Usha Rani	II BSC	G. Usha Rani
7	Kalla Pushpalakshmi	II BSC	K. pushpa lakshmi.
8	Kantamreddy Asha	II BSC	K. Asha
9	Karri Viswanadham	II BSC	K. Viswanadham.
10	Kolanti Anusha	II BSC	K. Anusha
11	M. Bhagyalakshmi	II BSC	M. Bhagya Lakshmi
12	Mogili Bhargavi	II BSC	M. Bhargavi
13	Moora Ratna Kumari	II BSC	M. Ratna Kumari
14	Ommi Kumari	II BSC	O. Kumari
15	Padala Triveni	II BSC	P. Triveni
16	Pedapudi Latha	II BSC	P. Latha
18	Pudi Kavya	II BSC	P. Kavya
19	Rajeswari Yanda	II BSC	Y. Rajeswari
20	Rangala Navya	II BSC	R. Navya
21	Reddi Daiva Madhuri	II BSC	R. Daiva madhuri
22	R. Venkatalakshmi	II BSC	R. Venkatalakshmi
23	Shaik Rahim Tunesha	II BSC	St. R. Tunesha
24	Sony Gudala	II BSC	Sony. Gudala
25	Telu Surya Lakshmi	II BSC	T. Surya lakshmi
26	Th. Mounika Devi	II BSC	Th. Mounika Devi
27	B. Sukanya	I BSC	B. Sukanya
28	B. Nookaratnam	I BSC	B. Nookaratnam
29	B. Tejasvi	I BSC	B. Tejasvi
30	B. Leela Praveena	I BSC	B. Leela Praveena
31	B. Divya Krupa	I BSC	B. Divya Krupa
32	B. Lavanya	I BSC	B. Lavanya
33	Ch. Swathi	I BSC	Ch. Swathi
34	Ch. Mokshasri	I BSC	Ch. Mokshasri
35	D. Sivaji	I BSC	D. Sivaji
36	D. Nissi Alekhya	I BSC	D. Nissi Alekhya
37	E. Hema Varaha Durga	I BSC	E. Hema Varaha Durga



S.G.A.GOVERNMENT DEGREE COLLEGE

(Re-accredited by NAAC with 'A' Grade, Affiliated to Andhra University)

YELLAMANCHILI - 531055, ANDHRA PRADESH



S.G.A.GOVERNMENT DEGREE COLLEGE

(Re-accredited by NAAC with 'A' Grade, Affiliated to Andhra University)

YELLAMANCHILI - 531055, ANDHRA PRADESH



21-22

38	G.Emmi Vinolini	I BSC	G: Emmivinalini
39	G.Dhikshitha	I BSC	G: Kifan Kanad
40	G.Kirankumar	I BSC	G: Rami
41	G.Rani	I BSC	G: Rami
42	J.Sindhu	I BSC	K: Valantha
43	K. Vasantha	I BSC	K: Valantha
44	K.Lakshmi	I BSC	K: Lakshmi
45	K.Loriya	I BSC	K: Loriya
46	K.Mounika	I BSC	K: Mounika
47	K.Kumari Sreelakshmi	I BSC	K: K. S. Lakshmi
48	Kdivya	I BSC	K: Divya
49	L.Yasawini	I BSC	L: Yasawini
50	M.Devi	I BSC	M: Devi
51	M.Nagalakshmi	I BSC	M: Nagalakshmi
52	M.Pushpalatha	I BSC	M: Pushpalatha
53	M.Sravani Sai	I BSC	M: Sravani Sai
54	M. Siva Sravani	I BSC	M: Siva Sravani
55	M. Navitha	I BSC	M: Siva Sravani
56	P.Pavani	I BSC	P: Pavani
57	P.Ratna Malathi Naveena	I BSC	P: R. M. Naveena
58	S.Divya	I BSC	S: Divya
59	T.Lohitha Sri	I BSC	T: Lohitha Sri
60	V.Sai	I BSC	V: Sai
61	V.Vineel	I BSC	V: Vineel
62	V.Jayasri	I BSC	V: Jayasri
63	V.Tulasi	I BSC	V: Tulasi
64	V.Uma Maheswari	I BSC	V: Uma Maheswari
65	N.Lakshmi Ganesh	II BCOM	N: Lakshmi Ganesh
66	P.Ganesh	II BCOM	P: Ganesh
67	P.Suryakala	II BCOM	P: Suryakala
68	P.Bhavani	II BCOM	P: Bhavani
69	P.Preetham	II BCOM	P: Preetham
70	P.Sukanya	II BCOM	P: Sukanya
71	P.Venkata Lakshmi	II BCOM	P: Venkata Lakshmi
73	R.Varalakshmi	II BCOM	R: Varalakshmi
74	S.Hymavathi	II BCOM	S: Hymavathi
75	S.Yakub Raju	II BCOM	S: Yakub Raju
76	T.Leela	II BCOM	T: Leela
77	U.Naveen	II BCOM	U: Naveen
78	U.Mayuri	II BCOM	U: Mayuri
79	G.Ganesh	III BSC	G: Ganesh
80	G.Sirisha rani	III BSC	G: Sirisha Rani
81	G.hari babu	III BSC	G: Hari Babu
82	K.Mahesh	III BSC	K: Mahesh
83	K.Appalaraju	III BSC	K: Appalaraju
84	K. Chinnari	III BSC	K: Chinnari
85	K.Prasadu	III BSC	K: Prasadu



S.G.A.GOVERNMENT DEGREE COLLEGE

(Re-accredited by NAAC with 'A' Grade, Affiliated to Andhra University)

VELLAMANCHILI - 531055, ANDHRA PRADESH



S.G.A.GOVERNMENT DEGREE COLLEGE

(Re-accredited by NAAC with 'A' Grade, Affiliated to Andhra University)

VELLAMANCHILI - 531055, ANDHRA PRADESH



28-11

85	K.Prasadu	III BSC	K. prasadu
86	K.Poornasai	III BSC	K. poornasai
87	K.Anitha	III BSC	K. Anitha
88	K.S.S. Shanker	III BSC	K. koothik
89	K.Karthik	III BSC	K. Karthik
90	K.Vasalakshi	III BSC	K. Vasalakshi
91	K.Suryamani	III BSC	K. Surya mani
92	K.Syamala	III BSC	K. Syamala
93	M.Kantham	III BSC	m. kantham
94	M.Sujatha	III BSC	m. Sujatha
95	N.Nookesh	III BSC	N. Nookesh
96	N.Anuradha	III BSC	N. Anuradha
97	P.Madhava	III BSC	P madhava
98	P.Narasinga Rao	III BSC	P. narasingh rao
99	P.Gangabhavani	III BSC	P. Ganga Bhavani
100	P.Priyanka	III BSC	P Priyanka
101	S.Vijay Lakshmi	III BSC	S. vijay lakshmi
102	S. Laxmi Devi	III BSC	S. laxmi devi
103	S.Swetha Rani	III BSC	S. swetha Rani
104	S.L.Shankara Rao	III BSC	S. L. Shankara Rao
105	S.Mangu Sree	III BSC	S. Mangu Sree



S.G.A.GOVERNMENT DEGREE COLLEGE

(Re-accredited by NAAC with 'A' Grade, Affiliated to Andhra University)

YELLAMANCHILI - 531055, ANDHRA PRADESH



CIRCULAR

Date: 19-02-2022

This is to inform all the students that as per the instructions received from the Principal of our college, it is intended to conduct "Yoga" as a regular practice to invoke the idea of good health and wealth in student community. As per his guidelines here in after every third Saturday of the month will be practiced Yoga in our college campus in the seminar hall from 3.00 pm to 5.00 pm. You will be guided by the college resource persons who are authenticated and well practitioners of Yoga. Your attendance will be marked and no permissions will be granted. You have to bring yoga-mat and come to college with white dress. You are instructed to avail this opportunity.

ProgrammeCO-
Ordinator

Yoga and Physical Fitness

Principal
S.G.A. Govt. Degree College
Yellamanchili-531 055
Anakapalli District. (A.P.)



S.G.A.GOVERNMENT DEGREE COLLEGE

(Re-accredited by NAAC with 'A' Grade, Affiliated to Andhra University)

YELLAMANCHILI - 531055, ANDHRA PRADESH



Department of Economics conducted Yoga and Meditation practice Class

programme conducted on 19-02-2022





S.G.A.GOVERNMENT DEGREE COLLEGE

(Re-accredited by NAAC with 'A' Grade, Affiliated to Andhra University)

YELLAMANCHILI - 531055, ANDHRA PRADESH



LIST OF STUDENTS ENROLLED AND PARTICIPATED IN YOGA AND MEDITATION 2018-19



S.G.A.GOVERNMENT DEGREE COLLEGE

(Re-accredited by NAAC with 'A' Grade, Affiliated to Andhra University)

YELLAMANCHILI - 531055, ANDHRA PRADESH



LIST OF STUDENTS ENROLLED AND PARTICIPATED IN YOGA AND MEDITATION 2018-19

21-22

S. No	Name of the Student	Group	Signature of the student
1	B.Gouri Devi	II BA	B. Gouri Devi
2	C.Harshavardhan	II BA	C. Harshavardhan
3	D.Av.V.S.N.Murthy	II BA	D. Av. V. S. N. Murthy
4	D.Pavan Kumar	II BA	D. Pavan Kumar
5	E.Sarawathi	II BA	E. Sarawathi
6	K.Srinivasa Rao	II BA	K. Srinivasa Rao
7	K.Mohan	II BA	K. Mohan
8	K.Durga Prasad	II BA	K. Durga Prasad
9	K.Appala Raju	II BA	K. Appala Raju
10	P.Munna	II BA	P. Munna
11	P.Durga Prasad	II BA	P. Durga Prasad
12	R.Venkalakshmi	II BA	R. Venkalakshmi
13	R.Ganesh	II BA	R. Ganesh
14	R.B.Aparna	II BA	R. B. Aparna
15	S.Dhanalakshmi	II BA	S. Dhanalakshmi
16	Y.Rama Teja	II BA	Y. Rama Teja
18	D. Padma	III BA	D. Padma
19	Bangaru Venu	I BA	B. Venu
20	Baithina Kusuma	I BA	B. Kusuma
21	Pendurthi Prasad	I BA	P. Prasad
22	Boddapu Tejarupini	I BA	B. Tejarupini
23	Dondaparthi Nani	I BA	D. Nani
24	G. Vijaya	I BA	G. Vijaya
25	G. Nukaratnam	I BA	G. Nukaratnam
26	Jajala Guna Sekhar	I BA	J. Guna Sekhar
27	M.D.N.S.Suryalaxmi	I BA	M. D. N. S. Suryalaxmi
28	M.Hemanth	I BA	M. Hemanth
29	Mylapalli Srinu	I BA	M. Srinu
30	P. Vinay Kumar	I BA	P. Vinay Kumar



S.G.A.GOVERNMENT DEGREE COLLEGE

(Re-accredited by NAAC with 'A' Grade, Affiliated to Andhra University)

YELLAMANCHILI - 531055, ANDHRA PRADESH



Physical Fitness





S.G.A.GOVERNMENT DEGREE COLLEGE

(Re-accredited by NAAC with 'A' Grade, Affiliated to Andhra University)

YELLAMANCHILI - 531055, ANDHRA PRADESH





S.G.A.GOVERNMENT DEGREE COLLEGE

(Re-accredited by NAAC with 'A' Grade, Affiliated to Andhra University)

YELLAMANCHILI - 531055, ANDHRA PRADESH





S.G.A. GOVERNMENT DEGREE COLLEGE

(Re-accredited by NAAC with 'A' Grade, Affiliated to Andhra University)

YELLAMANCHILI - 531055, ANDHRA PRADESH





S.G.A.GOVERNMENT DEGREE COLLEGE

(Re-accredited by NAAC with 'A' Grade, Affiliated to Andhra University)

YELLAMANCHILI - 531055, ANDHRA PRADESH





S.G.A.GOVERNMENT DEGREE COLLEGE

(Re-accredited by NAAC with 'A' Grade, Affiliated to Andhra University)

YELLAMANCHILI - 531055, ANDHRA PRADESH





S.G.A.GOVERNMENT DEGREE COLLEGE

(Re-accredited by NAAC with 'A' Grade, Affiliated to Andhra University)

YELLAMANCHILI - 531055, ANDHRA PRADESH





S.G.A.GOVERNMENT DEGREE COLLEGE

(Re-accredited by NAAC with 'A' Grade, Affiliated to Andhra University)

YELLAMANCHILI - 531055, ANDHRA PRADESH





S.G.A.GOVERNMENT DEGREE COLLEGE

(Re-accredited by NAAC with 'A' Grade, Affiliated to Andhra University)

YELLAMANCHILI - 531055, ANDHRA PRADESH





S.G.A.GOVERNMENT DEGREE COLLEGE

(Re-accredited by NAAC with 'A' Grade, Affiliated to Andhra University)

YELLAMANCHILI - 531055, ANDHRA PRADESH





S.G.A.GOVERNMENT DEGREE COLLEGE

(Re-accredited by NAAC with 'A' Grade, Affiliated to Andhra University)

YELLAMANCHILI - 531055, ANDHRA PRADESH



Health and Hygiene

SGA, GDC YELLAMANCHILI

**ORGANIZED CORONA VACCINATION DRIVE FOR 1ST YEAR STUDENTS AT
COLLEGE CAMPUS ON 06.01.2022**



**SGA GDC ORGANIZED VACCINATION ON COVID -19.34 STUDENTS WERE TAKEN
VACCINATION ON THAT DAY. NO STUDENT WAS LEFT WITHOUT A VACCINE. FROM THIS
PROGRAMME ENTIRE STUDENTS OF THE COLLEGE HAVE BEEN VACCINATED.**



S.G.A.GOVERNMENT DEGREE COLLEGE

(Re-accredited by NAAC with 'A' Grade, Affiliated to Andhra University)

YELLAMANCHILI - 531055, ANDHRA PRADESH



DEPARTMENT OF COMMERCE, STUDENTS PARTICIPATED IN INTERNATIONAL AIDS DAY ON 01.12.2021





S.G.A.GOVERNMENT DEGREE COLLEGE

(Re-accredited by NAAC with 'A' Grade, Affiliated to Andhra University)

YELLAMANCHILI - 531055, ANDHRA PRADESH





S.G.A.GOVERNMENT DEGREE COLLEGE

(Re-accredited by NAAC with 'A' Grade, Affiliated to Andhra University)

YELLAMANCHILI - 531055, ANDHRA PRADESH



SGA GDC YELLAMACHILI, NSS UNIT AWARENESS MEETING ON OMICRON VIRUS ON 05,01.2022





S.G.A.GOVERNMENT DEGREE COLLEGE

(Re-accredited by NAAC with 'A' Grade, Affiliated to Andhra University)

YELLAMANCHILI - 531055, ANDHRA PRADESH



WE ORGANISED AWARENESS MEETING ON OMICRAN VIRUS AND NSS VOLUNTEERS OF THE SGA DEGREE COLLEGE HAVE BEEN GIVEN AWARENESS ABOUT CORONA DISEASE AND WHAT KIND OF PRECAUTIONS ARE REQUIRED FOR NOT SPREADING THE DISEASE. SRI R. RAMA RAO, LEC IN COMMERCE, SRI V.A. SATYANARAYANA, LEC. IN TELUGU, SRI V.CHITTIBABU, NSS PROGRAMME OFFICER AND SRI M.KISHORE LEC.IN COMMERCE PARTICIPATED IN THIS MEETING.



S.G.A.GOVERNMENT DEGREE COLLEGE

(Re-accredited by NAAC with 'A' Grade, Affiliated to Andhra University)

YELLAMANCHILI - 531055, ANDHRA PRADESH



**DEPARTMENT OF COMMERCE,
STUDENTS PARTICIPATED IN CAMPUS CLEANING ON 26.10.2021**





S.G.A.GOVERNMENT DEGREE COLLEGE

(Re-accredited by NAAC with 'A' Grade, Affiliated to Andhra University)

YELLAMANCHILI - 531055, ANDHRA PRADESH





S.G.A.GOVERNMENT DEGREE COLLEGE

(Re-accredited by NAAC with 'A' Grade, Affiliated to Andhra University)

YELLAMANCHILI - 531055, ANDHRA PRADESH



**DEPARTMENT OF COMMERCE,
STUDENTS PARTICIPATED IN CAMPUS CLEANING ON 07.12.2021**





S.G.A.GOVERNMENT DEGREE COLLEGE

(Re-accredited by NAAC with 'A' Grade, Affiliated to Andhra University)

YELLAMANCHILI - 531055, ANDHRA PRADESH



**DEPARTMENT OF PHYSICS
ACTIVITY ON PLASTIC FREE CAMPUS 2020-21**



Activity on plastic free campus was conducted in the college campus on 04.03.2021 about 50 students participated in the activity.



S.G.A.GOVERNMENT DEGREE COLLEGE

(Re-accredited by NAAC with 'A' Grade, Affiliated to Andhra University)

YELLAMANCHILI - 531055, ANDHRA PRADESH



DEPARTMENT OF PHYSICS

ACTIVITY ON PLASTIC FREE CAMPUS 2021-22



Activity on plastic free campus was conducted in the college campus on 10.02.2022 about 60 students participated in the activity.



S.G.A.GOVERNMENT DEGREE COLLEGE

(Re-accredited by NAAC with 'A' Grade, Affiliated to Andhra University)

YELLAMANCHILI - 531055, ANDHRA PRADESH



Department of Botany

Activity: World Anti Tobacco Day

Group: All Groups of Students

Date: 31-05-2022



Dr. B. Chandramouli, In-Charge of the Dept. of Botany, Dr.V. Padmaja, Lecturer in Botany and Dr.A.ArjunaApparao, Lecturer in Zoology celebrated Anti Tobacco Day on 31-05-2022



S.G.A.GOVERNMENT DEGREE COLLEGE

(Re-accredited by NAAC with 'A' Grade, Affiliated to Andhra University)

YELLAMANCHILI - 531055, ANDHRA PRADESH



Women Empowerment Cell

Activity: World Milk Day

Group: II CBZ

Date: 29-06-2022





S.G.A.GOVERNMENT DEGREE COLLEGE

(Re-accredited by NAAC with 'A' Grade, Affiliated to Andhra University)

YELLAMANCHILI - 531055, ANDHRA PRADESH



**Women Empowerment Cell organised World Milk Day on
29-06-2022**



S.G.A.GOVERNMENT DEGREE COLLEGE

(Re-accredited by NAAC with 'A' Grade, Affiliated to Andhra University)

YELLAMANCHILI - 531055, ANDHRA PRADESH



DEPT. OF COMMERCE

ADD-ON COURSE: 2018-19

M.S.WORD

12-12-2018

Yellamanchili

SGA GOVT. DEGREE COLLEGE, YELLAMANCHILI

DEPARTMENT OF COMMERCE

DEPARTMENTAL MEETING

Minutes of the meeting

The faculty of department of Commerce met on 12-12-2018 and discussed the following matters

1. Resolve to start an add-on course in the Department of Commerce
2. To submit a letter to the principal for getting the permission to start an add-on course.
3. To prepare syllabus to the add-on course
4. To start the students with a minimum of 100 students.
5. To conduct six weeks add-on course 45 teaching and practical hours.
6. To conduct EXAM at the end of the Course and to issue course completion certificates to successfully completed students
7. Permission to utilize the Commerce Computer lab to conduct the practical for this add-on course.
8. Permission to conduct the add-on course by the Commerce faculty.
9. Continuing the add-on course for the next coming years.

P. Rangula

N. Nirmalakumari
HEAD

Department Of Commerce
SGA. Govt. Degree College
Yellamanchili - 531055
Visakhapatnam Dist.,

[Signature]

Principal
S.G.A. Govt. Degree College
YELLAMANCHILI - 531055
Visakhapatnam District.

PERMISSION LETTER TO START ADD-ON COURSE

FROM
THE HEAD OF THE DEPARTMENT,
DEPARTMENT OF COMMERCE
SGA GOVT. DEGREE COLLEGE
YELLAMANCHILI.

TO
PRINCIPAL,
SGA GOVT. DEGREE COLLEGE,
YELLAMANCHILI.

Sub: Permission to start an add-on course & and permission to nominate the
Commerce faculty as a faculty for that add-on course - regarding

REF: Resolution copy of the department of Commerce.

Respected sir,

As per the resolution of the department of Commerce we are very much interested to start an add-on course with a title Microsoft Office Word for the B.com (Gen) students, So, we are requesting you to give permission to start that add-on course and also permit us to act as the faculty for the add-on course.

P. Manjula

Thanking you sir.

Jr. Nirmala Kumar

HEAD

Department Of Commerce
SGA. Govt. Degree College
Yellamanchili - 531055
Visakhapatnam Dist.,

[Signature]

Principal

S.G.A. Govt. Degree College
YELLAMANCHILI - 531 055
Visakhapatnam District.

SGA GOVT. DEGREE COLLEGE, YELLAMANCHILI

DEPARTMENT OF COMMERCE

SYLLABUS

ADD-ON COURSE IN THE MICROSOFT OFFICE WORD-2010

UNIT-1 CREATE AND MANAGE DOCUMENTS

Create a document - Navigate through a Document – Format a Document – Customize Options and View for Documents – Print and Save Documents.

UNIT-2 FORMAT TEXT, PARAGRAPHS, AND SECTIONS

Insert Text and Paragraphs – Format Text and Paragraphs – Order and Group Text and Paragraphs.

UNIT-3 CREATE TABLES AND LISTS AND MANAGE REFERENCES

Create a Table – Modify a Table – Create and Modify a List – Create and Manage Reference Markers – Create and Manage Simple References.

UNIT – 4 INSERT AND FORMATE GRAPHIC ELEMENT, MANAGE DOCUMENT OPTIONS AND SETTINGS

Insert Graphic Elements – Format Graphic Elements – Insert and Format Smart Art Graphics – Manage Documents and Templates – Prepare Documents for Review – Manage Document Changes.

UNIT – 5 DESIGN ADVANCED DOCUMENTS AND CREATE ADVANCED REFERENCES.

Perform Advanced Editing and Formatting – Create Styles – Create and Manage Indexes – Create and Manage References – Manage Forms, Fields and mail Merge Option

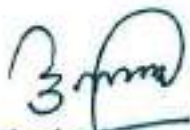

Principal

**S.G.A. Govt. Degree College
YELLAMANCHILI - 531055
Visakhapatnam District.**

Jr. Nirmala Kumari
HEAD

**Department Of Commerce
SGA. Govt. Degree College
Yellamanchili - 531055
Visakhapatnam Dist.,**

SGA GOVT. DEGREE COLLEGE, YELLAMANCHILI

DEPARTMENT OF COMMERCE

ACADEMIC YEAR-2018-19

ENROLLED STUDENTS FOR THE ADD-ON COURSE

MICROSOFT OFFICE WORD-2010

SL.NO	NAME	YEAR	GROUP	REGISTER NUMBER
1.	B. SIVA	III Year	B.com (Gen)	116135403002
2	B. KONDA BABU	III Year	B.com (Gen)	116135403003
3	B. NAGESWARA RAO	III Year	B.com (Gen)	116135403004
4	CH. NAGALAKSHMI	III Year	B.com (Gen)	116135403005
5	D. CHARAN RAJU	III Year	B.com (Gen)	116135403007
6	D. SRAVANI	III Year	B.com (Gen)	116135403008
7	E. NARASIMHA MURTHY	III Year	B.com (Gen)	116135403009
8	G. RAMU	III Year	B.com (Gen)	116135403010
9	G. NAGA SAI PUSPHA	III Year	B.com (Gen)	116135403012
10	G. DEVI	III Year	B.com (Gen)	116135403013
11	J. DEVI	III Year	B.com (Gen)	116135403014
12	J. BHARATHI	III Year	B.com (Gen)	116135403015
13	J. DURGA PRASAD	III Year	B.com (Gen)	116135403016
14	K. BALAGANGA	III Year	B.com (Gen)	116135403017
15	K. RAJU	III Year	B.com (Gen)	116135403018
16	K. VEERA LAKSHMI	III Year	B.com (Gen)	116135403019
17	K. SESHU BABU	III Year	B.com (Gen)	116135403020
18	K. INDU	III Year	B.com (Gen)	116135403022
19	K. SAI TULASI	III Year	B.com (Gen)	116135403023
20	K. MAHA LAKSHMI	III Year	B.com (Gen)	116135403024
21	K. MURALI	III Year	B.com (Gen)	116135403025
22	K. NAGA KUMAR	III Year	B.com (Gen)	116135403026
23	K. SATYA NARAYANA	III Year	B.com (Gen)	116135403027
24	K. SATYA DURGA PRASAD	III Year	B.com (Gen)	116135403028
25	K. KASU	III Year	B.com (Gen)	116135403029
26	K. NAGA LAKSHMI	III Year	B.com (Gen)	116135403030
27	L. KRUPAVATHI	III Year	B.com (Gen)	116135403031
28	M. MANIKYAM	III Year	B.com (Gen)	116135403033
29	M. JYOTHI	III Year	B.com (Gen)	116135403034
30	M. RAMA DEVI	III Year	B.com (Gen)	116135403035
31	N. KASI	III Year	B.com (Gen)	116135403036
32	P. NAGARATNAM	III Year	B.com (Gen)	116135403037
33	P. HYMA	III Year	B.com (Gen)	116135403039
34	R. GOVINDU	III Year	B.com (Gen)	116135403042
35	S. DURGA PRASAD	III Year	B.com (Gen)	116135403044
36	S. SURYA KUMARI	III Year	B.com (Gen)	116135403045

37	S. RAJU	III Year	B.com (Gen)	119135403046
38	S. SATYAVANI	III Year	B.com (Gen)	116135403047
39	T. SHANTHI	III Year	B.com (Gen)	116135403049
40	T. SWAMY	III Year	B.com (Gen)	116135403050
41	U. PUSPHA LATHA	III Year	B.com (Gen)	116135403052
42	V. RAMU	III Year	B.com (Gen)	116135403054
43	V. AJAY	III Year	B.com (Gen)	116135403055
44	V. APPALARAJU	III Year	B.com (Gen)	116135403057
45	A. GANESH	II Year	B.com (Gen)	117135403001
46	A. ANUSHA	II Year	B.com (Gen)	117135403002
47	B. ROOPAKALA	II Year	B.com (Gen)	117135403003
48	B. BHAVANI	II Year	B.com (Gen)	117135403004
49	CH. SUJATHA	II Year	B.com (Gen)	117135403005
50	CH KOTESWARI	II Year	B.com (Gen)	117135403006
51	E. BHARATHI	II Year	B.com (Gen)	117135403007
52	G. BHANU	II Year	B.com (Gen)	117135403009
53	H. PARSAD	II Year	B.com (Gen)	117135403012
54	J. VASUDEVARAO	II Year	B.com (Gen)	117135403013
55	J. SRAVANI	II Year	B.com (Gen)	117135403014
56	J. KARUNA	II Year	B.com (Gen)	117135403015
57	K. DEVI	II Year	B.com (Gen)	117135403016
58	K. DEVI PARVATHI	II Year	B.com (Gen)	117135403017
59	K. NAGA GOWRI	II Year	B.com (Gen)	117135403018
60	K. PRABHAVATHI	II Year	B.com (Gen)	117135403019
61	K. SUNEETHA	II Year	B.com (Gen)	117135403020
62	K. TRIMURTHULU	II Year	B.com (Gen)	117135403021
63	K. NAGA VENKATESH	II Year	B.com (Gen)	117135403022
64	K. VARA LAKSHMI	II Year	B.com (Gen)	117135403023
65	K. MANI BHASHA	II Year	B.com (Gen)	117135403024
66	K. MOHAN	II Year	B.com (Gen)	117135403025
67	K. RAMALAKSHMI	II Year	B.com (Gen)	117135403026
68	K. REVATHI	II Year	B.com (Gen)	117135403027
69	K. SRAVANI	II Year	B.com (Gen)	117135403028
70	K. BHAVANI	II Year	B.com (Gen)	117135403029
71	K. DEVI	II Year	B.com (Gen)	117135403030
72	K. JYOTHI	II Year	B.com (Gen)	117135403031
73	K. AMMAJI	II Year	B.com (Gen)	117135403033
74	M. VASANTHA	II Year	B.com (Gen)	117135403036
75	M. KAMESWARI	II Year	B.com (Gen)	117135403037
76	M. DIVYA	II Year	B.com (Gen)	117135403038
77	M. RAVI	II Year	B.com (Gen)	117135403039
78	M. PRASAD	II Year	B.com (Gen)	117135403040
79	N. VENNELA	II Year	B.com (Gen)	117135403041
80	N. KOTESWARA RAO	II Year	B.com (Gen)	117135403042
81	P. PRIYANKA RANI	II Year	B.com (Gen)	117135403043
82	P. SHIVANI	II Year	B.com (Gen)	117135403044
83	P. RAMYA	II Year	B.com (Gen)	117135403045
84	P. JAGADESH	II Year	B.com (Gen)	117135403046
85	P. LAVANYA	II Year	B.com (Gen)	117135403047
86	P. BHARATHI	II Year	B.com (Gen)	117135403048

87	R. JYOTHI	II Year	B.com (Gen)	117135403049
88	R. GANGA LAKSHMI	II Year	B.com (Gen)	117135403050
89	R. LAVANYA	II Year	B.com (Gen)	117135403051
90	R. LAVANYA	II Year	B.com (Gen)	117135403052
91	S. NAGA DEVI	II Year	B.com (Gen)	117135403053
92	S. BALAMANI	II Year	B.com (Gen)	117135403054
93	S. SATYA	II Year	B.com (Gen)	117135403055
94	S. LAVANYA	II Year	B.com (Gen)	117135403056
95	T. LEELA KUMARI	II Year	B.com (Gen)	117135403057
96	V. BHARTHI	II Year	B.com (Gen)	117135403058
97	V. VENKATA LAKSHMI SRAVANI	II Year	B.com (Gen)	117135403059
98	V. VIDYA	II Year	B.com (Gen)	117135403060
99	V. HARI BABU	II Year	B.com (Gen)	117135403061
100	Y. DIVYA	II Year	B.com (Gen)	117135403062

P. S. Lakshmi

M. Nirmala Kumar
 HEAD
 Department Of Commerce
 SGA, Govt. Degree College
 Yellamanchili - 531055
 Visakhapatnam Dist.

S. M. M.
 Principal
 S.G.A. Govt. Degree College
 YELLAMANCHILI - 531 055
 Visakhapatnam District.



S.G.A. GOVERNMENT DEGREE COLLEGE
(Re-accredited by NAAC with 'A' Grade, Affiliated to Andhra University)
YELLAMANCHILI - 531055, ANDHRA PRADESH



DEPARTMENT OF COMMERCE
CERTIFICATE OF MS WORD

This is to certify that Mr./Kum S. LAVANYA
S/o / D/o _____ Regd.No- 117135403056
has successfully completed the Add-on course in "MS WORD" in this college held
from 13-12-2018 to 15-01-19 and awarded with 'A' Grade.

N. Nirmalakumari

HEAD OF THE DEPARTMENT



3/1/19

Principal



S.G.A. GOVERNMENT DEGREE COLLEGE
(Re-accredited by NAAC with 'A' Grade, Affiliated to Andhra University)
YELLAMANCHILI - 531055, ANDHRA PRADESH



DEPARTMENT OF COMMERCE
CERTIFICATE OF MS WORD

This is to certify that Mr./Kum Y. DIVYA
S/o / D/o _____ Regd.No- 117135403062
has successfully completed the Add-on course in "MS WORD" in this college held
from 13-12-2018 to 15-01-2019 and awarded with 'A' Grade.

N. Nirmalakumari

HEAD OF THE DEPARTMENT



3/1/19

Principal

Final Exam Question Paper

ADD ON COURSE: M.S. WORD

Max marks: 25*1=25

1. In which view Headers and Footers are visible ()
A. Normal View
B. Print Layout View
C. Page Layout View
D. Draft View
2. The process of removing unwanted part of an image is called ()
A. Hiding
B. Bordering
C. Cropping
D. Cutting
3. To apply center alignment to a paragraph we can press ()
A. Ctrl+S
B. Ctrl+C
C. Ctrl+C+A
D. Ctrl+E
4. The space left between the margin and the start of a paragraph is called ()
A. Spacing
B. Gutter
C. Indentation
D. Alignment
5. Text-styling feature of MS Word is ()
A. WordColor
B. WordFont
C. WordArt
D. WordFill
6. Which items are placed at the end of a document ()
A. Footer
B. Foot Note
C. End Note
D. Header
7. To change line height to 1.5 we use shortcut key: ()
A. Ctrl+1
B. Ctrl+2
C. Ctrl+3
D. Ctrl+5
8. A number of letter that appears little above the normal text is called ()
A. Superscript
B. Subscript
C. Supertext
D. Toptext
9. A number of letter that appears little below the normal text is called ()
A. Superscript
B. Subscript
C. Supertext
D. Toptext
10. We can insert a page number at ()
A. Header
B. Footer
C. Both A and B
D. None
11. Which one can be used as watermark in a word document ()
A. Text
B. Image
C. Both A and B
D. None
12. Which item appears dimly behind the main body text ()
A. Water Color
B. Background
C. Watermark
D. Back Color
13. Which feature starts a new line whenever a word or sentence reached a border ()
A. Text Line
B. New Line
C. Text Wrapping
D. Text Align
14. The direction of a rectangular page for viewing and printing is called ()
A. Orientation
B. Direction
C. Print Layout
D. Preview
15. We can remove/ hide border of a shape by selecting ()
A. No Line
B. No Out Lin
C. White Line
D. No Border
16. We can change the thickness of a line from ()
A. Line width
B. Line Height
C. Line thick
D. Line Style

17. What item contains detailed information about something in the text ()
 A. Footer B. Foot Note
 B. Header C. Head Note
18. Which item is printed at the bottom of each page ()
 A. Header B. Foot Note
 C. Title D. Footer
19. Color and pattern used to fill a closed shape is called ()
 A. Shape B. WordArt
 C. Fill Style D. Fill Back
20. Where footnotes appear in document ()
 A. End of Document B. Bottom of a page
 C. End of Heading D. None
21. The file type _____ Indicates the file is a word document ()
 A. msw B. wor
 C. wrd D. doc
22. What is the maximum number of lines you can set for lines to drop box ()
 A. 3 B. 5
 C. 10 D. 15
23. What is the shortcut key for 'Subscript' the selected text ()
 A. Ctrl+= B. Ctrl+-
 C. Ctrl+shift+= D. Ctrl+shift+-
24. Which key is used to increase left indent ()
 A. Ctrl+I B. Ctrl+M
 C. Alt+I D. F10
25. Word includes a series of predefined graphics called _____ that can be inserted into ()
 A word document
 A. Clip Art B. Hyperlinks
 B. Captions D. Bookmarks

P. Raju

N. Nirmala Kumar

HEAD
 Department Of Commerce
 SGA, Govt. Degree College
 Yellamanchili - 531055
 Visakhapatnam Dist.,

ADD-ON COURSE: MICROSOFT OFFICE WORD
KEY PAPER

1.C 2.C 3.D 4.C 5.C 6.C 7.D 8.A 9.B 10.C
11.C 12. C 13. C 14. A 15. B 16.D 17. B 18. D 19. C 20. B
21. D 22. C 23. A 24. B 25. A

P. Rayudu

N. Nirmala Keerani
HEAD

Department of Commerce
SUA, Govt. Degree College
Yellamanchili - 531004
Visakhapatnam Dist.

SGA GOVT. DEGREE COLLEGE, YELLAMANCHILI
 DEPARTMENT OF COMMERCE
 ENROLLED STUDENTS FOR THE ADDON COURSE
 MICROSOFT OFFICE WORD

S.NO	NAME	YEAR	GROUP	REGISTER NUMBER	STUDENT SIGNATURE
1	B.SIVA	III Year	B.com (Gen)	116135403002	B. Siva
2	B.KONDA BABU	III Year	B.com (Gen)	116135403003	B. Konda Babu
3	B.NAGESWARA RAO	III Year	B.com (Gen)	116135403004	B. Nageswara Rao
4	CH.NAGALAKSHMI	III Year	B.com (Gen)	116135403005	Ch. Nagalakshmi
5	D.CHARAN RAJU	III Year	B.com (Gen)	116135403007	D. Charan Raju
6	D.SRAVANI	III Year	B.com (Gen)	116135403008	D. Sravani
7	E.NARASIMHA MURTHY	III Year	B.com (Gen)	116135403009	E. Narasimha Murthy
8	G.RAMU	III Year	B.com (Gen)	116135403010	G. Ramu
9	G.NAGA SAI PUSPHA	III Year	B.com (Gen)	116135403012	G. Naga Sai Puspha
10	G.DEVI	III Year	B.com (Gen)	116135403013	G. Devi
11	J.DEVI	III Year	B.com (Gen)	116135403014	J. Devi
12	J.BHARATHI	III Year	B.com (Gen)	116135403015	J. Bharathi
13	J.DURGA PRASAD	III Year	B.com (Gen)	116135403016	J. Durga Prasad
14	K.BALAGANGA	III Year	B.com (Gen)	116135403017	K. Balaganga
15	K.RAJU	III Year	B.com (Gen)	116135403018	K. Raju
16	K.VEERA LAKSHMI	III Year	B.com (Gen)	116135403019	K. Veera Lakshmi
17	K.SESHU BABU	III Year	B.com (Gen)	116135403020	K. Seshu Babu
18	K.INDU	III Year	B.com (Gen)	116135403022	K. Indu
19	K.SAI TULASI	III Year	B.com (Gen)	116135403023	K. Sai Tulasi
20	K.MAHA LAKSHMI	III Year	B.com (Gen)	116135403024	K. Maha Lakshmi
21	K.MURALI	III Year	B.com (Gen)	116135403025	K. Murali
22	K.NAGA KUMAR	III Year	B.com (Gen)	116135403026	K. Naga Kumar
23	K.SATYA NARAYANA	III Year	B.com (Gen)	116135403027	K. Satya Narayana
24	K.SATYA DURGA PRASAD	III Year	B.com (Gen)	116135403028	K. Satya Durga Prasad
25	K.KASU	III Year	B.com (Gen)	116135403029	K. Kasu
26	K.NAGA LAKSHMI	III Year	B.com (Gen)	116135403030	K. Naga Lakshmi
27	L.KRUPAVATHI	III Year	B.com (Gen)	116135403031	L. Krupavathi
28	M.MANIKYAM	III Year	B.com (Gen)	116135403033	M. Manikyam
29	M.JYOTHI	III Year	B.com (Gen)	116135403034	M. Jyothi
30	M.RAMA DEVI	III Year	B.com (Gen)	116135403035	M. Rama Devi
31	N.KASI	III Year	B.com (Gen)	116135403036	N. Kasi
32	P.NAGARATNAM	III Year	B.com (Gen)	116135403037	P. Hy MA
33	P.HYMA	III Year	B.com (Gen)	116135403039	P. Hyma
34	R.GOVINDU	III Year	B.com (Gen)	116135403042	R. Govindu
35	S.DURGA PRASAD	III Year	B.com (Gen)	116135403044	S. Durga Prasad

P. Harjula

V. Nirmala Kumar
 HEAD
 Department Of Commerce
 SGA. Govt. Degree College
 Yellamanchili - 531055
 Visakhapatnam Dist.,

B. [Signature]
 Principal
 S.G.A Govt. Degree College
 Yellamanchili - 531 055

SGA GOVT. DEGREE COLLEGE, YELLAMANCHILI
DEPARTMENT OF COMMERCE
ENROLLED STUDENTS FOR THE ADDON COURSE
MICROSOFT OFFICE WORD

S.NO	NAME	YEAR	GROUP	REGISTER NUMBER	STUDENT SIGNATURE
36	S.SURYA KUMARI	III Year			
37	S.RAJU	III Year	B.com (Gen)	116135403045	S. Surya Kumari
38	S.SATYAVANI	III Year	B.com (Gen)	116135403046	S. Ralu
39	T.SHANTHI	III Year	B.com (Gen)	116135403047	S. Satyavan
40	T.SWAMY	III Year	B.com (Gen)	116135403049	T. Shanthi
41	U.PUSPHA LATHA	III Year	B.com (Gen)	116135403050	T. Swamy
42	V.RAMU	III Year	B.com (Gen)	116135403052	T. Swamy
43	V.AJAY	III Year	B.com (Gen)	116135403054	V. Ramu
44	V.APPALARAJU	III Year	B.com (Gen)	116135403055	V. Ajay
45	A.GANESH	II Year	B.com (Gen)	116135403057	V. Appalaraju
46	A.ANUSHA	II Year	B.com (Gen)	116135403001	A. Ganesh
47	B.ROOPAKALA	II Year	B.com (Gen)	116135403002	A. Anusha
48	B.BHAVANI	II Year	B.com (Gen)	116135403003	B. Roopakala
49	CH.SUJATHA	II Year	B.com (Gen)	116135403004	B. Bhavani
50	CH.KOTESWARI	II Year	B.com (Gen)	116135403005	Ch. Sujatha
51	E.BHARATHI	II Year	B.com (Gen)	116135403006	Ch. Koteswari
52	G.BHANU	II Year	B.com (Gen)	116135403007	E. Bharathi
53	H.PRASAD	II Year	B.com (Gen)	116135403009	G. Bhanu
54	J.VASUDEVARAO	II Year	B.com (Gen)	116135403012	H. Prasad
55	J.SRAVANI	II Year	B.com (Gen)	116135403013	J. Vasudevarao
56	J.KARUNA	II Year	B.com (Gen)	116135403014	J. Sravani
57	K.DEVI	II Year	B.com (Gen)	116135403015	J. Karuna
58	K.DEVI PARVATHI	II Year	B.com (Gen)	116135403016	K. Devi
59	K.NAGA GOWRI	II Year	B.com (Gen)	116135403017	K. Devi Parvathi
60	K.PRABHAVATHI	II Year	B.com (Gen)	116135403018	K. Naga Gowri
61	K.SUNEETHA	II Year	B.com (Gen)	116135403019	K. Prabhavathi
62	K.TRIMURTHULU	II Year	B.com (Gen)	116135403020	K. Suneetha
63	K.NAGA VENKATESH	II Year	B.com (Gen)	116135403021	K. Trimurthulu
64	K.VARA LAKSHMI	II Year	B.com (Gen)	116135403022	K. Naga Venkatesh
65	K.MANI BHASHA	II Year	B.com (Gen)	116135403023	K. Vara Lakshmi
66	K.MOHAN	II Year	B.com (Gen)	116135403024	K. Mani Bhasha
67	K.RAMALAKSHMI	II Year	B.com (Gen)	116135403025	K. Mohan
68	K.REVATHI	II Year	B.com (Gen)	116135403026	K. Ramalakshmi
69	K.SRAVANI	II Year	B.com (Gen)	116135403027	K. Revathi
70	K.BHAVANI	II Year	B.com (Gen)	116135403028	K. Sravani
				116135403029	K. Bhavani

P. Mangula

N. N. Vinoda Keshavi
HEAD

Department Of Commerce
S.G.A. Govt. Degree College
Yellamanchili - 531055
Visakhapatnam Dist.

S. M.
Principal

S.G.A. Govt. Degree College
Yellamanchili - 531 055

S.NO	NAME	YEAR	GROUP	REGISTER NUMBER	STUDENT SIGNATURE
71	K.DEVI	II Year	B.com (Gen)	116135403030	K. Devi
72	K.JYOTHI	II Year	B.com (Gen)	116135403031	K. Jyothi
73	K.MMAJI	II Year	B.com (Gen)	116135403033	K. Mmaji
74	M.VASANTHI	II Year	B.com (Gen)	116135403036	M. Vasanthi
75	M.KAMESWARI	II Year	B.com (Gen)	116135403037	M. Kameswari
76	M.DIYYA	II Year	B.com (Gen)	116135403038	M. Diyya
77	M.RAVI	II Year	B.com (Gen)	116135403039	M. Ravi
78	M.PRASAD	II Year	B.com (Gen)	116135403040	M. Prasad
79	N.VENNELA	II Year	B.com (Gen)	116135403041	N. Vennela
80	N.KOTESWARA RAO	II Year	B.com (Gen)	116135403042	N. K. Rao
81	P.PRIYANKA RANI	II Year	B.com (Gen)	116135403043	P. Priyanka Rani
82	P.SHIVANI	II Year	B.com (Gen)	116135403044	P. Shivani
83	P.RAMYA	II Year	B.com (Gen)	116135403045	P. Ramya
84	P.JAGADESH	II Year	B.com (Gen)	116135403046	P. Jagadesh
85	P.LAVANYA	II Year	B.com (Gen)	116135403047	P. Lavanya
86	P.BHARATHI	II Year	B.com (Gen)	116135403048	P. Bharathi
87	R.JYOTHI	II Year	B.com (Gen)	116135403049	R. Jyothi
88	R.GANGA LAKSHMI	II Year	B.com (Gen)	116135403050	R. Ganga Lakshmi
89	R.LAVANYA	II Year	B.com (Gen)	116135403051	R. Lavanya
90	R.LAVANYA	II Year	B.com (Gen)	116135403052	R. Lavanya
91	S.NAGA DEVI	II Year	B.com (Gen)	116135403053	S. Naga Devi
92	S.BALAMANI	II Year	B.com (Gen)	116135403054	S. Balamani
93	S.SATYA	II Year	B.com (Gen)	116135403055	S. Satya
94	S.LAVANYA	II Year	B.com (Gen)	116135403056	S. Lavanya
95	T.LEELA KUMARI	II Year	B.com (Gen)	116135403057	T. Leela Kumari
96	V.BHARATHI	II Year	B.com (Gen)	116135403058	V. Bharathi
97	V.VENKATA LAKSHMI GALAMANI	II Year	B.com (Gen)	116135403059	V. V. Lakshmi
98	V.DIYA	II Year	B.com (Gen)	116135403060	V. Diya
99	V.HARI BABU	II Year	B.com (Gen)	116135403061	V. Hari Babu
100	Y.DIYYA	II Year	B.com (Gen)	116135403062	Y. Diyya

1

P. Manjula

N. Nirmala Kumar

HEAD

Department Of Commerce
S.G.A. Govt. Degree College
Yellamanchili - 531055
Visakhapatnam Dist.S. Ulu
PrincipalS.G.A. Govt. Degree College
Yellamanchili-531 055

ATTENDANCE SHEET

S. NO	NAME	Date																												STUDENT SIGNATURE	
		19/12/18	20/12/18	21/12/18	22/12/18	23/12/18	24/12/18	25/12/18	26/12/18	27/12/18	28/12/18	29/12/18	30/12/18	31/12/18	1/1/19	2/1/19	3/1/19	4/1/19	5/1/19	6/1/19	7/1/19	8/1/19	9/1/19	10/1/19	11/1/19	12/1/19	13/1/19	14/1/19	15/1/19		
1	B. SIVA	P	P	P	P	P	P	P	P	P	P	P	P	P	P	P	P	P	P	P	P	P	P	P	P	P	P	P	P	P	B. SIVA
2	B. KONDA BABU	P	P	P	P	P	P	P	P	P	P	P	P	P	P	P	P	P	P	P	P	P	P	P	P	P	P	P	P	P	B. Konda Babu
3	B. NAGESWARA MO	P	P	P	P	P	P	P	P	P	P	P	P	P	P	P	P	P	P	P	P	P	P	P	P	P	P	P	P	P	B. Nageswara Mo
4	CH. NAGALAKSHMI	P	P	P	P	P	P	P	P	P	P	P	P	P	P	P	P	P	P	P	P	P	P	P	P	P	P	P	P	P	Ch. Nagalakshmi
5	D. CHARAN RAJU	P	P	P	P	P	P	P	P	P	P	P	P	P	P	P	P	P	P	P	P	P	P	P	P	P	P	P	P	P	D. Charan Raju
6	D. SRAVANI	P	P	P	P	P	P	P	P	P	P	P	P	P	P	P	P	P	P	P	P	P	P	P	P	P	P	P	P	P	D. Sravani
7	E. NARASIMHA MURTHY	P	P	P	P	P	P	P	P	P	P	P	P	P	P	P	P	P	P	P	P	P	P	P	P	P	P	P	P	P	E. Narasimha Murthy
8	G. RAMU	P	P	P	P	P	P	P	P	P	P	P	P	P	P	P	P	P	P	P	P	P	P	P	P	P	P	P	P	P	G. Ramu
9	G. NAGA SAI PUSPHA	P	P	P	P	P	P	P	P	P	P	P	P	P	P	P	P	P	P	P	P	P	P	P	P	P	P	P	P	P	G. Naga Sai Puspha
10	G. DEVI	P	P	P	P	P	P	P	P	P	P	P	P	P	P	P	P	P	P	P	P	P	P	P	P	P	P	P	P	P	G. Devi
11	I. DEVI	P	P	P	P	P	P	P	P	P	P	P	P	P	P	P	P	P	P	P	P	P	P	P	P	P	P	P	P	P	I. Devi
12	J. BHARATHI	P	P	P	P	P	P	P	P	P	P	P	P	P	P	P	P	P	P	P	P	P	P	P	P	P	P	P	P	P	J. Bharathi
13	J. DURGA PRASAD	P	P	P	P	P	P	P	P	P	P	P	P	P	P	P	P	P	P	P	P	P	P	P	P	P	P	P	P	P	J. Durga Prasad
14	K. BALAGANGA	P	P	P	P	P	P	P	P	P	P	P	P	P	P	P	P	P	P	P	P	P	P	P	P	P	P	P	P	P	K. Balaganga
15	K. RAJU	P	P	P	P	P	P	P	P	P	P	P	P	P	P	P	P	P	P	P	P	P	P	P	P	P	P	P	P	P	K. Raju
16	K. VEERA LAKSHMI	P	P	P	P	P	P	P	P	P	P	P	P	P	P	P	P	P	P	P	P	P	P	P	P	P	P	P	P	P	K. Veera Lakshmi
17	K. SESHU BABU	P	P	P	P	P	P	P	P	P	P	P	P	P	P	P	P	P	P	P	P	P	P	P	P	P	P	P	P	P	K. Seshu Babu
18	E. INDU	P	P	P	P	P	P	P	P	P	P	P	P	P	P	P	P	P	P	P	P	P	P	P	P	P	P	P	P	P	E. Indu
19	E. SAI TULASI	P	P	P	P	P	P	P	P	P	P	P	P	P	P	P	P	P	P	P	P	P	P	P	P	P	P	P	P	P	E. Sai Tulasi
20	K. MAHA LAKSHMI	P	P	P	P	P	P	P	P	P	P	P	P	P	P	P	P	P	P	P	P	P	P	P	P	P	P	P	P	P	K. Maha Lakshmi
21	K. MURALI	P	P	P	P	P	P	P	P	P	P	P	P	P	P	P	P	P	P	P	P	P	P	P	P	P	P	P	P	P	K. Murali
22	K. NAGA KUMAR	P	P	P	P	P	P	P	P	P	P	P	P	P	P	P	P	P	P	P	P	P	P	P	P	P	P	P	P	P	K. Naga Kumar
23	K. SATYA NARAYANA	P	P	P	P	P	P	P	P	P	P	P	P	P	P	P	P	P	P	P	P	P	P	P	P	P	P	P	P	P	K. Satya Narayana
24	K. SATYA DURGA PRASAD	P	P	P	P	P	P	P	P	P	P	P	P	P	P	P	P	P	P	P	P	P	P	P	P	P	P	P	P	P	K. S.D. Prasad
25	K. KASU	P	P	P	P	P	P	P	P	P	P	P	P	P	P	P	P	P	P	P	P	P	P	P	P	P	P	P	P	P	K. Kasu
26	K. NAGA LAKSHMI	P	P	P	P	P	P	P	P	P	P	P	P	P	P	P	P	P	P	P	P	P	P	P	P	P	P	P	P	P	K. Naga Lakshmi
27	L. KRUPAVATHI	P	P	P	P	P	P	P	P	P	P	P	P	P	P	P	P	P	P	P	P	P	P	P	P	P	P	P	P	P	L. Krupavathi
28	M. MANIKYAM	P	P	P	P	P	P	P	P	P	P	P	P	P	P	P	P	P	P	P	P	P	P	P	P	P	P	P	P	P	M. Manikyam
29	M. JYOTHI	P	P	P	P	P	P	P	P	P	P	P	P	P	P	P	P	P	P	P	P	P	P	P	P	P	P	P	P	P	M. Jyothi
30	M. RAMA DEVI	P	P	P	P	P	P	P	P	P	P	P	P	P	P	P	P	P	P	P	P	P	P	P	P	P	P	P	P	P	M. Rama Devi
31	N. KASI	P	P	P	P	P	P	P	P	P	P	P	P	P	P	P	P	P	P	P	P	P	P	P	P	P	P	P	P	P	N. Kasi
32	P. NAGARATNAM	P	P	P	P	P	P	P	P	P	P	P	P	P	P	P	P	P	P	P	P	P	P	P	P	P	P	P	P	P	P. Nagaratnam
33	P. HYMA	P	P	P	P	P	P	P	P	P	P	P	P	P	P	P	P	P	P	P	P	P	P	P	P	P	P	P	P	P	P. Hyma
34	R. GOVINDU	P	P	P	P	P	P	P	P	P	P	P	P	P	P	P	P	P	P	P	P	P	P	P	P	P	P	P	P	P	R. Govindu
35	S. DURGA PRASAD	P	P	P	P	P	P	P	P	P	P	P	P	P	P	P	P	P	P	P	P	P	P	P	P	P	P	P	P	P	S. Durga Prasad
36	S. SURIYA KUMARI	P	P	P	P	P	P	P	P	P	P	P	P	P	P	P	P	P	P	P	P	P	P	P	P	P	P	P	P	P	S. Suriya Kumari
37	S. RAJU	P	P	P	P	P	P	P	P	P	P	P	P	P	P	P	P	P	P	P	P	P	P	P	P	P	P	P	P	P	S. Raju
38	S. SATYAVANI	P	P	P	P	P	P	P	P	P	P	P	P	P	P	P	P	P	P	P	P	P	P	P	P	P	P	P	P	P	S. Satyavani
39	T. SHANTHI	P	P	P	P	P	P	P	P	P	P	P	P	P	P	P	P	P	P	P	P	P	P	P	P	P	P	P	P	P	T. Shanthi
40	T. SWAMY	P	P	P	P	P	P	P	P	P	P	P	P	P	P	P	P	P	P	P	P	P	P	P	P	P	P	P	P	P	T. Swamy
41	U. PUSPHA LATHA	P	P	P	P	P	P	P	P	P	P	P	P	P	P	P	P	P	P	P	P	P	P	P	P	P	P	P	P	P	U. Puspha Latha
42	V. RAMU	P	P	P	P	P	P	P	P	P	P	P	P	P	P	P	P	P	P	P	P	P	P	P	P	P	P	P	P	P	V. Ramu
43	V. AJAY	P	P	P	P	P	P	P	P	P	P	P	P	P	P	P	P	P	P	P	P	P	P	P	P	P	P	P	P	P	V. Ajay
44	V. APPALARAJU	P	P	P	P	P	P	P	P	P	P	P	P	P	P	P	P	P	P	P	P	P	P	P	P	P	P	P	P	P	V. Appalaraju
45	A. GANESH	P	P	P	P	P	P	P	P	P	P	P	P	P	P	P	P	P	P	P	P	P	P	P	P	P	P	P	P	P	A. Ganesh
46	A. ANUSHA	P	P	P	P	P	P	P	P	P	P	P	P	P	P	P	P	P	P	P	P	P	P	P	P	P	P	P	P	P	A. Anusha
47	B. ROOPAKALA	P	P	P	P	P	P	P	P	P	P	P	P	P	P	P	P	P	P	P	P	P	P	P	P	P	P	P	P	P	B. Roopakala
48	B. BHAVANI	P	P	P	P	P	P	P	P	P	P	P	P	P	P	P	P	P	P	P	P	P	P	P	P	P	P	P	P	P	B. Bhavani
49	CH. SUJATHA	P	P	P	P	P	P	P	P	P	P	P	P	P	P	P	P	P	P	P	P	P	P	P	P	P	P	P	P	P	Ch. Sujatha

P. Karjula

N. Nirmalakumari
HEAD
 Department Of Commerce
 SGA. Govt. Degree College
 Yellamanchili - 531055
 Visakhapatnam Dist.

S.M.
Principal
 S.G.A. Govt. Degree College
 Yellamanchili - 531055
 Visakhapatnam Dist.

ATTENDANCE SHEET

S. NO	NAME	Date																												STUDENT SIGNATURE							
		13/12/18	14/12/18	15/12/18	16/12/18	17/12/18	18/12/18	19/12/18	20/12/18	21/12/18	22/12/18	23/12/18	24/12/18	25/12/18	26/12/18	27/12/18	28/12/18	29/12/18	30/12/18	31/12/18	1/1/19	2/1/19	3/1/19	4/1/19	5/1/19	6/1/19	7/1/19	8/1/19	9/1/19		10/1/19	11/1/19	12/1/19	13/1/19	14/1/19	15/1/19	
50	CH. KOTESWARI	P	P	P	P	P	P	P	P	P	P	P	P	P	P	P	P	P	P	P	P	P	P	P	P	P	P	P	P	P	P	P	P	P	P	P	Ch. Koteswari
51	E. BHARATHI	P	P	P	P	P	P	P	P	P	P	P	P	P	P	P	P	P	P	P	P	P	P	P	P	P	P	P	P	P	P	P	P	P	P	P	E. Bharathi
52	G. BHANU	A	A	P	P	P	P	P	P	P	P	P	P	P	P	P	P	P	P	P	P	P	P	P	P	P	P	P	P	P	P	P	P	P	P	G. Bhanu	
53	H. PRASAD	P	P	P	P	P	P	P	P	P	P	P	P	P	P	P	P	P	P	P	P	P	P	P	P	P	P	P	P	P	P	P	P	P	P	H. Prasad	
54	I. VASUDEVARAO	P	P	P	P	P	P	P	P	P	P	P	P	P	P	P	P	P	P	P	P	P	P	P	P	P	P	P	P	P	P	P	P	P	P	I. Vasudevarao	
55	I. SRIVANI	P	P	P	P	P	P	P	P	P	P	P	P	P	P	P	P	P	P	P	P	P	P	P	P	P	P	P	P	P	P	P	P	P	P	I. Srivani	
56	I. KARUNA	P	P	P	P	P	P	P	P	P	P	P	P	P	P	P	P	P	P	P	P	P	P	P	P	P	P	P	P	P	P	P	P	P	P	I. Karuna	
57	K. DEVI	A	P	P	P	P	P	P	P	P	P	P	P	P	P	P	P	P	P	P	P	P	P	P	P	P	P	P	P	P	P	P	P	P	P	K. Devi	
58	K. DEVI PARVATHI	P	P	P	P	P	P	P	P	P	P	P	P	P	P	P	P	P	P	P	P	P	P	P	P	P	P	P	P	P	P	P	P	P	P	K. Devi Parvathi	
59	K. NAGA GOWRI	P	P	P	P	P	P	P	P	P	P	P	P	P	P	P	P	P	P	P	P	P	P	P	P	P	P	P	P	P	P	P	P	P	P	K. Naga Gowri	
60	K. PRABHAVATHI	P	P	P	P	P	P	P	P	P	P	P	P	P	P	P	P	P	P	P	P	P	P	P	P	P	P	P	P	P	P	P	P	P	P	K. Prabhavathi	
61	K. SUMEETHA	P	P	P	P	P	P	P	P	P	P	P	P	P	P	P	P	P	P	P	P	P	P	P	P	P	P	P	P	P	P	P	P	P	P	K. Sumeetha	
62	K. TRIMURTHULU	P	P	P	P	P	P	P	P	P	P	P	P	P	P	P	P	P	P	P	P	P	P	P	P	P	P	P	P	P	P	P	P	P	P	K. Trimurthulu	
63	K. NAGA VENKATESH	P	P	P	P	P	P	P	P	P	P	P	P	P	P	P	P	P	P	P	P	P	P	P	P	P	P	P	P	P	P	P	P	P	P	K. Naga Venkatesh	
64	K. VARA LAKSHMI	P	P	P	P	P	P	P	P	P	P	P	P	P	P	P	P	P	P	P	P	P	P	P	P	P	P	P	P	P	P	P	P	P	P	K. Vara Lakshmi	
65	K. MANI BHASHA	P	P	P	P	P	P	P	P	P	P	P	P	P	P	P	P	P	P	P	P	P	P	P	P	P	P	P	P	P	P	P	P	P	P	K. Mani Bhasha	
66	K. MOHAN	P	P	P	P	P	P	P	P	P	P	P	P	P	P	P	P	P	P	P	P	P	P	P	P	P	P	P	P	P	P	P	P	P	P	K. Mohan	
67	K. RAMALAKSHMI	P	P	P	P	P	P	P	P	P	P	P	P	P	P	P	P	P	P	P	P	P	P	P	P	P	P	P	P	P	P	P	P	P	P	K. Ramalakshmi	
68	K. REVATHI	P	P	P	P	P	P	P	P	P	P	P	P	P	P	P	P	P	P	P	P	P	P	P	P	P	P	P	P	P	P	P	P	P	P	K. Revathi	
69	K. SRIVANI	P	P	P	P	P	P	P	P	P	P	P	P	P	P	P	P	P	P	P	P	P	P	P	P	P	P	P	P	P	P	P	P	P	P	K. Srivani	
70	K. BHAVANI	P	P	P	P	P	P	P	P	P	P	P	P	P	P	P	P	P	P	P	P	P	P	P	P	P	P	P	P	P	P	P	P	P	P	K. Bhavani	
71	K. DEVI	P	P	P	P	P	P	P	P	P	P	P	P	P	P	P	P	P	P	P	P	P	P	P	P	P	P	P	P	P	P	P	P	P	P	K. Devi	
72	K. JYOTHI	A	P	P	P	P	P	P	P	P	P	P	P	P	P	P	P	P	P	P	P	P	P	P	P	P	P	P	P	P	P	P	P	P	P	K. Jyothi	
73	K. MMALI	P	P	P	P	P	P	P	P	P	P	P	P	P	P	P	P	P	P	P	P	P	P	P	P	P	P	P	P	P	P	P	P	P	P	K. Mmali	
74	M. VASANTHI	P	P	P	P	P	P	P	P	P	P	P	P	P	P	P	P	P	P	P	P	P	P	P	P	P	P	P	P	P	P	P	P	P	P	M. Vasanthi	
75	M. KAMESHWARI	P	P	P	P	P	P	P	P	P	P	P	P	P	P	P	P	P	P	P	P	P	P	P	P	P	P	P	P	P	P	P	P	P	P	M. Kameshwari	
76	M. DIVYA	P	P	P	P	P	P	P	P	P	P	P	P	P	P	P	P	P	P	P	P	P	P	P	P	P	P	P	P	P	P	P	P	P	P	M. Divya	
77	M. RAVI	P	P	P	P	P	P	P	P	P	P	P	P	P	P	P	P	P	P	P	P	P	P	P	P	P	P	P	P	P	P	P	P	P	P	M. Ravi	
78	M. PRASAD	P	P	P	P	P	P	P	P	P	P	P	P	P	P	P	P	P	P	P	P	P	P	P	P	P	P	P	P	P	P	P	P	P	P	M. Prasad	
79	N. VENNELA	P	P	P	P	P	P	P	P	P	P	P	P	P	P	P	P	P	P	P	P	P	P	P	P	P	P	P	P	P	P	P	P	P	P	N. Vennela	
80	N. KOTESWARA RAO	P	P	P	P	P	P	P	P	P	P	P	P	P	P	P	P	P	P	P	P	P	P	P	P	P	P	P	P	P	P	P	P	P	P	N. Koteswara Rao	
81	P. PRIYANKA RANI	P	P	P	P	P	P	P	P	P	P	P	P	P	P	P	P	P	P	P	P	P	P	P	P	P	P	P	P	P	P	P	P	P	P	P. Priyanka Rani	
82	P. SHIVANI	P	P	P	P	P	P	P	P	P	P	P	P	P	P	P	P	P	P	P	P	P	P	P	P	P	P	P	P	P	P	P	P	P	P	P. Shivani	
83	P. RAMYA	P	P	P	P	P	P	P	P	P	P	P	P	P	P	P	P	P	P	P	P	P	P	P	P	P	P	P	P	P	P	P	P	P	P	P. Ramya	
84	P. JAGADESH	P	P	P	P	P	P	P	P	P	P	P	P	P	P	P	P	P	P	P	P	P	P	P	P	P	P	P	P	P	P	P	P	P	P	P. Jagadesh	
85	P. LAVANYA	P	P	P	P	P	P	P	P	P	P	P	P	P	P	P	P	P	P	P	P	P	P	P	P	P	P	P	P	P	P	P	P	P	P	P. Lavanya	
86	P. BHARATHI	P	P	P	P	P	P	P	P	P	P	P	P	P	P	P	P	P	P	P	P	P	P	P	P	P	P	P	P	P	P	P	P	P	P	P. Bharathi	
87	P. JYOTHI	P	P	P	P	P	P	P	P	P	P	P	P	P	P	P	P	P	P	P	P	P	P	P	P	P	P	P	P	P	P	P	P	P	P	P. Jyothi	
88	P. GANGA LAKSHMI	P	P	P	P	P	P	P	P	P	P	P	P	P	P	P	P	P	P	P	P	P	P	P	P	P	P	P	P	P	P	P	P	P	P	P. Ganga Lakshmi	
89	P. LAVANYA	P	P	P	P	P	P	P	P	P	P	P	P	P	P	P	P	P	P	P	P	P	P	P	P	P	P	P	P	P	P	P	P	P	P	P. Lavanya	
90	P. LAVANYA	P	P	P	P	P	P	P	P	P	P	P	P	P	P	P	P	P	P	P	P	P	P	P	P	P	P	P	P	P	P	P	P	P	P	P. Lavanya	
91	S. NAGA DEVI	P	P	P	P	P	P	P	P	P	P	P	P	P	P	P	P	P	P	P	P	P	P	P	P	P	P	P	P	P	P	P	P	P	P	S. Naga Devi	
92	S. BALAMANI	P	P	P	P	P	P	P	P	P	P	P	P	P	P	P	P	P	P	P	P	P	P	P	P	P	P	P	P	P	P	P	P	P	P	S. Balamani	
93	S. SATYA	P	P	P	P	P	P	P	P	P	P	P	P	P	P	P	P	P	P	P	P	P	P	P	P	P	P	P	P	P	P	P	P	P	P	S. Satya	
94	S. LAVANYA	P	P	P	P	P	P	P	P	P	P	P	P	P	P	P	P	P	P	P	P	P	P	P	P	P	P	P	P	P	P	P	P	P	P	S. Lavanya	
95	T. JEELA KUMARI	P	P	P	P	P	P	P	P	P	P	P	P	P	P	P	P	P	P	P	P	P	P	P	P	P	P	P	P	P	P	P	P	P	P	T. Jeela Kumari	
96	V. BHARATHI	P	P	P	P	P	P	P	P	P	P	P	P	P	P	P	P	P	P	P	P	P	P	P	P	P	P	P	P	P	P	P	P	P	P	V. Bharathi	
97	V. VENKATESH KRISHNA	P	P	P	P	P	P	P	P	P	P	P	P	P	P	P	P	P	P	P	P	P	P	P	P	P	P	P	P	P	P	P	P	P	P	V. Venkatesh Krishna	
98	V. DIVYA	P	P	P	P	P	P	P	P	P	P	P	P	P	P	P	P	P	P	P	P	P	P	P	P	P	P	P	P	P	P	P	P	P	P	V. Divya	

P. Marjula

N. Srivani Kumari
HEAD
 Department Of Commerce
 SGA. Govt. Degree College
 Yellamanchili - 531055
 Visakhapatnam Dist.

S. S. Srinivasulu
Principal
 S.G.A. Govt. Degree Coll:
 Yellamanchili-531 055

Microsoft Word

Brief Summary:

This Microsoft Word training course aims to provide new users with the essential skills needed to create, edit and print professional looking documents using text, tables, lists and pictures as well as covering simple mail merge. Particular emphasis is placed on developing accurate and well-designed documents.

The course begins by showing you how to navigate around Microsoft Word. It then quickly gets you to create a new document before moving onto features such as text manipulation and enhancement, creating and using tabs and tables, embellishing documents with clip art and pictures, creating multiple documents through merging and printing documents.

Outcomes:

By the end of this course, you should be able to:

- work with the basic features of Word
- create a new document
- work with a document
- display documents using various views
- select and work with text in a document
- use a range of font formatting techniques
- format paragraphs
- work effectively with features that affect the page layout of your document
- create and modify tabs and tables
- insert and work with clip art and pictures
- use the Mail Merge Wizard to perform mail merges
- print a document
- find the information you need in Help
- create high quality document designs and layouts.

P. Kalyan

N. Nirmala Kumar
HEAD
Department Of Commerce
S.G.A. Govt. Degree College,
Yellamanchili - 531055
Visakhapatnam Dist.

B. S. Reddy
Principal
S.G.A. Govt. Degree College,
Yellamanchili - 531 055

2-2

Date : 05-02-2020,

Yellamanchili.

SGA GOVT. DEGREE COLLEGE
DEPARTMENT OF COMPUTER SCIENCE
DEPARTMENTAL MEETING

MINUTES OF MEETING :

1. Resolve to start an add on course in the department of computer science.
2. To submit a letter to principal for getting the permission to start an add on course.
3. To prepare the syllabus to the add on course
4. To start the course with a minimum of 20 students.
5. To conduct six week add on course including 30 teaching and practical hours.
6. Permission to conduct add on course by the computer science faculty.
7. Continuing the add on course for the next three years.

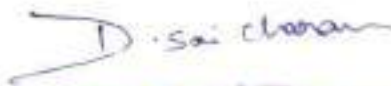
Lecturer in Computer Science
SGA GDC
YELLAMANCHILI

Permission letter to start an add on course

From

The Head of the department,
Department of Computer Science,
SGA Govt Degree College, Yellamanchili

To

The Principal
SGA Govt Degree College.
Yellamanchili.

Sub : Permission to start an add on course and permission to nominate the computer science faculty as the faculty for add on course.- regarding.

Ref : Resolution copy of the department of computer science.

Respected sir,

As per the resolution of the department of computer science we are very much interested to start an add on course with the title "MS Office" for the B.sc MPCS students. So we are requesting you to give permission to start that add on course and also permit us to act as the faculty for the add on course.

Thanking you sir,

D. Sai Charam
Lecturer in C.T. & I.T.
SGA Govt Degree College
Yellamanchili

SGA GOVT. DEGREE COLLEGE
DEPARTMENT OF COMPUTER SCIENCE

Add on course in MS OFFICE

Syllabus

Unit 1

MS word: Word Processing – Features-Advantages and Applications- Parts of Word Window Toolbar- Creating, Saving, Closing, Opening and Editing of a Document- Moving and Coping a Text- Formatting of Text and Paragraph- Bullets and Numbering- Find and Replace - Insertion of objects- Headers and Footers- Page Formatting- Auto Correct Spelling and Grammar- Mail Merge- Macros.

Unit 2

MS Excel: Features – Spread Sheet-Workbook – Cell-Parts of a window-Saving, Closing, Opening of a Work Book – Editing – Advantages – Formulas- Types of Function-Templates – Macros – Sorting- Charts – Filtering.

Unit 3

MS Power point: Introduction – Starting – Parts-Creating of Tables- Create Presentation – Templates-Auto Content Wizard-Slide Show-Editing of Presentation-Inserting Objects and charts.

 S. S. Chandra

Lecturer in Computer Science
- SGA GDC
VELLAMANCHILI

SGA GOVT. DEGREE COLLEGE
DEPARTMENT OF COMPUTER SCIENCE

Enrolled students for the Add on Course

S.no	RegNo	SNAME	
1	718135405045	ARLANKI SRAVANI	A. Sravani
2	718135405046	CHELLURI NOOKA RATNAM	C. Nooka Ratnam
3	718135405047	CHITTIBOMMALA ANIL KUMAR	ca Anil Kumar
4	718135405048	DASARI ANUSHA	D. Anusha
5	718135405049	GANAGALLA RAJU	G. Raju
6	718135405050	GANDHAM SIREESHA	G. Sireesha
7	718135405051	GOLAGANI GANGAAPPARAO	G. Ganga Apparao
8	718135405052	ILLAPU SANDHYA	I. Sandhya
9	718135405054	KANAPARTHI DURGA	K. Durga
10	718135405055	KANDELA RAVI KUMAR	K. Ravi Kumar
11	718135405056	KANNAMREDDI NEELAVENI	K. Neelaveni
12	718135405057	KATTUMURI NIKHILA	K. Nikhila
13	718135405058	MAMIDI RAMAKRISHNA	M. Ramakrishna
14	718135405059	MANABALA DURGA LOVA LAKSHMI	M.D. Lova Lakshmi
15	718135405060	MARRI RAMYASRI	M. Ramya Sree
16	718135405061	NADIGATLA SUDHARSHAN	N. Sudharshan
17	718135405062	NARAVA SIVA PRASAD	N. Siva Prasad
18	718135405063	PALIVELA PRIYAKSHI	P. Priyakshi
19	718135405064	PENKE GOVIND	P. Govind
20	718135405065	PONNADA SUPRIYA	P. Supriya
21	718135405066	SAMMENGI BHAGYASRI	S. Bhagyasree
22	718135405068	SIVAKOTI VENKATA SNEHITHA	S. Venkata Snehitia

D. Sai Charan

with M.Computer Science
 - 500
 10/10/2023

SGA GOVT. DEGREE COLLEGE, YELLAMANCHILI

DEPARTMENT OF COMPUTER SCIENCE

ADD-ON COURSE in MS OFFICE

Attendance sheet of enrolled students for the add on course

Course from		05 - 02 - 2020		to		25 - 02 - 2020		Duration		: 30 hrs							Signature	
S. No	Student Name	05/02	06/02	07/02	10/02	11/02	12/02	13/02	14/02	15/02	17/02	18/02	19/02	20/02	22/02	24/02	25/02	
1	ARLANKI SHAVANI	P	P	P	P	P	P	A	P	P	P	P	P	A	P	P	P	A. Shavani
2	CHELLURI NOOKA RATNAM	P	A	P	P	P	P	P	P	P	P	A	P	P	P	P	P	C. Noora Ratnam
3	CHITTIROMMALA ANIL KUMAR	P	P	A	P	P	P	P	P	P	A	P	P	P	P	P	P	CH. Anilkumar
4	DASARI ANUSHA	P	P	P	P	P	P	P	P	A	A	P	P	P	P	P	P	D. Anusha
5	GANAGALLA RAJU	P	P	A	A	P	P	P	P	P	P	P	P	P	P	A	P	G. Raju
6	GANDHAM SIRESHA	P	P	P	P	P	P	P	P	A	P	P	P	P	P	P	A	S. Siresha
7	GOLAGANI GANGAAPPARAO	P	P	P	P	A	P	P	P	P	P	P	P	P	A	A	P	G. Gangaappa
8	ILLAPU SANDHYA	P	P	P	A	P	P	P	P	A	P	P	P	P	P	P	P	I. Sandhya
9	KANAPARTHI DURGA	A	P	P	P	P	P	A	P	P	P	P	P	P	P	P	P	K. Durga
10	KANDELA RAVI KUMAR	P	P	P	A	P	P	P	P	P	P	A	P	P	P	P	P	K. Ravi Kumar
11	KANNAMREDDI NETLA VENI	P	P	P	P	A	P	P	A	P	P	P	P	P	P	P	P	K. Netla Veni
12	KATTUMURI NIKHILA	P	P	P	P	P	A	P	P	P	P	P	P	P	P	P	P	K. Nikhila
13	MAMIDI RAMAKRISHNA	P	P	A	P	P	P	P	P	P	P	P	P	A	P	P	P	M. Rama Krishna
14	MANABALA DURGA LOVA LAKSHMI	P	P	P	P	P	P	P	P	A	P	P	P	P	P	P	A	M. D. Lova Lakshmi
15	MARRI RAMYASRI	P	P	P	P	P	P	A	P	P	P	P	A	P	P	P	P	M. Ramyasri
16	NADIGATLA SUDHARSHAN	P	P	P	A	P	P	P	P	P	A	P	P	P	P	P	P	N. Sudharshan
17	NARAVA SIVA PRASAD	P	A	P	P	P	P	P	P	A	P	P	P	P	P	P	P	N. Siva Prasad
18	PALIVELA PRIYAKSHI	P	P	P	P	P	P	P	P	P	P	P	P	P	P	P	P	P. Priyashri
19	PENKE GOVIND	P	P	P	P	P	P	P	P	P	P	P	P	P	P	P	P	P. Govind
20	PONNADA SUPRIYA	P	A	P	P	P	P	P	P	P	P	P	P	P	P	P	A	P. Supriya
21	SAMME NGI BHAGYASHI	P	P	P	P	P	P	P	P	P	A	P	P	P	A	P	P	S. Bhagyashri
22	SIVAKOTI VENKATA SNEHITHA	P	P	A	P	P	P	P	P	P	P	P	P	P	P	A	P	S. Venkata Snehitha

D. Sankaran



S.G.A.GOVERNMENT DEGREE COLLEGE
(Re-accredited by NAAC with 'A' Grade, Affiliated to Andhra University)
VELLAMANCHILI - 531055, ANDHRA PRADESH



Department of Computer Science

Add Course on "MS Office" Exam

Time : 1 hour Max Marks : 30

I. Answer all of the following questions. 3*10=30M

1. Explain parts of MS Word Window?
2. Explain how to prepare a ppt?
3. Explain how to Edit data in MS-Excel?

[Handwritten Signature]
Department of Computer Science

[Handwritten Signature]
Principal
S.G.A. Govt. Degree College
Vellamanchili - 531055



S.G.A.GOVERNMENT DEGREE COLLEGE

(Re-accredited by NAAC with 'A' Grade, Affiliated to Andhra University)

YELLAMANCHILI- 531055, ANDHRA PRADESH



DEPARTMENT OF COMPUTER SCIENCE

Add - on Course in MS OFFICE for the academic year 2019-20

SUMMARY REPORT

The department of COMPUTER SCIENCE has started Add - on course on "MS OFFICE " with 22 students from all final years of SGA GDC. Department of COMPUTER SCIENCE conducted 30 classes to complete the syllabus within stipulated time from 05/02/2020 to 25/02/2020. The exams were conducted to registered students for 30 marks and issued certificates to all students.

MS-OFFICE is one of the important employment field in present era. There are many opportunities to students in social media and web designing. So Department of COMPUTER SCIENCE introduced this course for the benefit of students in their future .All the students were presented and gained proper knowledge in MS OFFICE .

- 1 . Number of students enrolled : 22
2. Number of students completed : 22
3. Classes conducted :30 hours
4. Maximum marks : 30 marks
5. Time : morning and evening 2 hours.

D. Sai Charam
Course Co - Ordinator
Lecturer in Computer Science
SGA GDC
YELLAMANCHILI

principal



S.G.A.GOVERNMENT DEGREE COLLEGE

(Re-accredited by NAAC with 'A' Grade, Affiliated to Andhra University)

VELLAMANCHILI - 531055, ANDHRA PRADESH



DEPARTMENT OF COMPUTER SCIENCE

ADD-ON COURSE IN

"MS-OFFICE"

CERTIFICATE

This is to certify that Mr./Ku _____ S/o/D/o _____

Regd. No _____ has successfully completed the add-on course in

"MS OFFICE" in this college held from _____ to _____.

D. Sai Charan

Head of the Department

P. S. S. S. S. S.
VELLAMANCHILI

The Principal

SGA GOVT. DEGREE COLLEGE
DEPARTMENT OF COMPUTER SCIENCE

Add on course in WEB DESIGNING

Syllabus

Unit 1

Website designing:

Designing a home page, HTML document, Anchor tag Hyperlinks, Head and body section, Header Section, Title, Prologue, Links, Colorful Pages, Comment, Body Section, Heading Horizontal Ruler, Paragraph, Tabs, Images And Pictures, Lists and Their Types, Nested Lists, Table Handling, Frames: Frameset Definition, Frame Definition, Nested Framesets, Forms and Form Elements.

Unit 2

DHTML :

DHTML and Style Sheets: Defining Styles, elements of Styles, linking a style sheet to a HTML Document, Inline Styles, External Style Sheets, Internal Style Sheets & Multiple Style Sheets. V

Unit 3

Security and Encryption:

Need and Concepts, E-Commerce Security Environment: (Dimension, Definition and Scope Of E-Security), Security Threats in The E-Commerce Environment (Security Intrusions And Breaches, Attacking Methods Like Hacking, Sniffing, Cyber-Vandalism Etc.), Technology Solutions (Encryption, Security Channels Of Communication, Protecting Networks And Protecting Servers And Clients)

D. Sai charan

Lecturer in Computer Science

SGA GDC
YELLAMANCHILI

P. Ch
Principal
S.G.A. Govt. Degree College
Yellamanchili-534 055

Date : 14-02-2022,

Yellamanchili.

SGA GOVT. DEGREE COLLEGE
DEPARTMENT OF COMPUTER SCIENCE
DEPARTMENTAL MEETING

MINUTES OF MEETING :

1. Resolve to start an add on course in the department of computer science.
2. To submit a letter to principal for getting the permission to start an add on course.
3. To prepare the syllabus to the add on course
4. To start the course with a minimum of 20 students.
5. To conduct add on course with the duration of 30 teaching and practical hours.
6. Permission to conduct add on course by the computer science faculty.
7. Continuing the add on course for the next three years.

D. Sai charan

Asst. Prof. Computer Science

P. Chidambaram

Principal
S.G.A.Govt.Degree College
YELLAMANCHILI - 531 035
Visakhapatnam District.

Permission letter to start an add on course

From

The Head of the department,
Department of Computer Science,
S.G.A.Govt.DegreeCollege,
Yellamanchili.

To

The Principal
SGA Govt Degree College.
Yellamanchili.

Sub : Permission to start an add on course and permission to nominate the
computer science faculty as the faculty for add on course.- regarding.

Ref : Resolution copy of the department of computer science.

Respected sir,

As per the resolution of the department of computer science we are very
much interested to start an add on course with the title "WEB DESIGNING" for B.sc
MPCS students. So we are requesting you to give permission to start that add on course and
also permit us to act as the faculty for the add on course.

Thanking you sir,

D. Sai charan

Head of the Department
Computer Science
S.G.A. Govt. Degree College
Yellamanchili

P. Chandraiah

Principal
S.G.A.Govt.Degree College
YELLAMANCHILI - 531 035
Visakhapatnam District.

SGA GOVT. DEGREE COLLEGE
DEPARTMENT OF COMPUTER SCIENCE

Add on course in WEB DESIGNING

Syllabus

Unit 1

Website designing:

Designing a home page, HTML document, Anchor tag Hyperlinks, Head and body section, Header Section, Title, Prologue, Links, Colorful Pages, Comment, Body Section, Heading Horizontal Ruler, Paragraph, Tabs, Images And Pictures, Lists and Their Types, Nested Lists, Table Handling, Frames: Frameset Definition, Frame Definition, Nested Framesets, Forms and Form Elements.

Unit 2

DHTML :

DHTML and Style Sheets: Defining Styles, elements of Styles, linking a style sheet to a HTML Document, Inline Styles, External Style Sheets, Internal Style Sheets & Multiple Style Sheets. V

Unit 3

Security and Encryption:

Need and Concepts, E-Commerce Security Environment: (Dimension, Definition and Scope Of E-Security), Security Threats in The E-Commerce Environment (Security Intrusions And Breaches, Attacking Methods Like Hacking, Sniffing, Cyber-Vandalism Etc.), Technology Solutions (Encryption, Security Channels Of Communication, Protecting Networks And Protecting Servers And Clients)

D. Sai charan

Lect. - Computer Science

SGA GOVT. DEGREE COLLEGE
DEPARTMENT OF COMPUTER SCIENCE

Enrolled students for the Add on Course

SL.NO	NAME	YEAR	GROUP	REGISTER NUMBER	Signature
1.	A.PAPARAYUDU	2 nd YEAR	B.Sc.	720135405030	A. Paparayudu
2.	A.APARNA	2 nd YEAR	B.Sc.	720135405031	A. Aparna
3.	A.SOWMYA	2 nd YEAR	B.Sc.	720135405033	A. Sowmya
4.	ARAVIND.E	2 nd YEAR	B.Sc.	720135405034	Aravind E.
5.	BALAJI.B	2 nd YEAR	B.Sc.	720135405035	Balaji B.
6.	B.RAMADEVI	2 nd YEAR	B.Sc.	720135405036	B. Ramadevi
7.	D.BHAVANI	2 nd YEAR	B.Sc.	720135405037	B. Bhavani
8.	D.PRASAD	2 nd YEAR	B.Sc.	720135405038	D. Prasad
9.	D.N.NAGALAXMI	2 nd YEAR	B.Sc.	720135405039	D. N. nagamani
10.	G.SAMBHAVIDEVI	2 nd YEAR	B.Sc.	720135405040	G. Sambhavidevi
11.	J.JYOTHI	2 nd YEAR	B.Sc.	720135405041	J. jyothis
12.	K.SATHYA	2 nd YEAR	B.Sc.	720135405042	K. Satya
13.	K.KAVITHA	2 nd YEAR	B.Sc.	720135405043	K. kavitha
14.	K.PRASAD	2 nd YEAR	B.Sc.	720135405044	K. Prasad
15.	K.TRIVENI	2 nd YEAR	B.Sc.	720135405045	K. TRIVENI
16.	K.NAVYA	2 nd YEAR	B.Sc.	720135405046	K. navya
17.	K.ROHINI	2 nd YEAR	B.Sc.	720135405047	K. Rohini
18.	M.VASUNDARA	2 nd YEAR	B.Sc.	720135405048	M. Vasundara
19.	M.RAMANI	2 nd YEAR	B.Sc.	720135405049	M. Ramani
20.	M.ASHOK	2 nd YEAR	B.Sc.	720135405050	M. Ashok
21.	M.RUPA	2 nd YEAR	B.Sc.	720135405051	M. Rupa
22.	M.SANDEEP	2 nd YEAR	B.Sc.	720135405052	M. Sandeep
23.	N.LEELALAXMI	2 nd YEAR	B.Sc.	720135405053	N. leelalakshmi
24.	N.JAHNAVI	2 nd YEAR	B.Sc.	720135405054	N. Jahnavi
25.	N.B.K.D.LAXMIDEVI	2 nd YEAR	B.Sc.	720135405055	N. B. K. D. laxmidevi
26.	N.SRIDEVI	2 nd YEAR	B.Sc.	720135405056	N. Sridevi
27.	P.HEMALATHA	2 nd YEAR	B.Sc.	720135405057	P. Hemalatha
28.	P.SRIDEVI	2 nd YEAR	B.Sc.	720135405058	P. Sridevi
29.	P.RAMAKRISHNA	2 nd YEAR	B.Sc.	720135405059	P. Ramakrishna
30.	P.HARIKA	2 nd YEAR	B.Sc.	720135405060	P. harika
31.	S.USHASRI	2 nd YEAR	B.Sc.	720135405061	S. Ushasri
32.	S.GANESHRISAI	2 nd YEAR	B.Sc.	720135405062	S. Ganeshrisai
33.	T.PRASANNAKUMARI	2 nd YEAR	B.Sc.	720135405063	T. Prasanna Kumari
34.	T.PALLAVI	2 nd YEAR	B.Sc.	720135405064	T. Pallavi
35.	T.MANIKANTA	2 nd YEAR	B.Sc.	720135405065	T. Manikanta
36.	V.RAMALAXMI	2 nd YEAR	B.Sc.	720135405066	V. Ramalaxmi
37.	V.SIMHADRI	2 nd YEAR	B.Sc.	720135405067	V. Simhadri
38.	Y.NAGADURGA	2 nd YEAR	B.Sc.	720135405068	Y. Nagadurga
39.	AKKAPU HEMANTH	1 st YEAR	B. SC	721135405041	A. hemanth
40.	ANALA KARUNA KUMARI	1 st YEAR	B. SC	721135405042	A. karunakumari
41.	BHEEMUNI DURGA	1 st YEAR	B. SC	721135405043	B. Durga
42.	B.MANIKANTA SWAMY	1 st YEAR	B. SC	721135405044	B. manikantam

43.	BODDETI EESWANYA	1 st YEAR	B.SC	721135405045	B. Eeswanya
44.	BOTTA KRISHNA KUMAR	1 st YEAR	B.SC	721135405046	B. Krishna Kumar
45.	CHEBROLU BHARGAVI	1 st YEAR	B.SC	721135405047	C. Bhargavi
46.	DABBIRU JYOTSNA	1 st YEAR	B.SC	721135405048	D. Jyothsna
47.	DARA SHIVA	1 st YEAR	B.SC	721135405049	D. Shiva
48.	D. GANESH ABHI RAM	1 st YEAR	B.SC	721135405050	D. Ganesh Abhiram
49.	E. NAGA VARALAKSHMI	1 st YEAR	B.SC	721135405051	E. Naga Varalakshmi
50.	GATTEM PRASANNA	1 st YEAR	B.SC	721135405052	G. Prasanna
51.	GOLAJANA SRINIVAS	1 st YEAR	B.SC	721135405053	G. Srinivas
52.	GUTALA SAI	1 st YEAR	B.SC	721135405054	G. Sai
53.	I. VARA BHAVANI	1 st YEAR	B.SC	721135405055	I. Vara Bhavani
54.	KAKI SUJINI GAYATHRI	1 st YEAR	B.SC	721135405056	K. Sujini Gayathri
55.	KARANAM BHAGYASREE	1 st YEAR	B.SC	721135405057	K. Bhagyashree
56.	KARRI VINAY	1 st YEAR	B.SC	721135405058	K. Vinay
57.	KOSURU YAMINI DEVI	1 st YEAR	B.SC	721135405059	K. Yamini Devi
58.	KOYLADA PAVANI	1 st YEAR	B.SC	721135405060	K. Pavani
59.	L. RAJITH KUMAR	1 st YEAR	B.SC	721135405061	L. Rajith Kumar
60.	M. MANIKANTA SWAMY	1 st YEAR	B.SC	721135405062	M. Manikanta Swamy
61.	MALIREDDY YASHODA	1 st YEAR	B.SC	721135405063	M. Yashoda
62.	MAMIDI SAI	1 st YEAR	B.SC	721135405064	M. Sai
63.	MANJETI SRIKANTH	1 st YEAR	B.SC	721135405065	M. Srikanth
64.	MARRA K.N.D.M.G.BHAVANI	1 st YEAR	B.SC	721135405066	M. K.N.D.M.G. Bhavani
65.	MARRI SUJA	1 st YEAR	B.SC	721135405067	M. Suja
66.	MOKA HARIKA MADHU VANI	1 st YEAR	B.SC	721135405068	M. Harika Madhu Vani
67.	MUTYALA SANTHOSH	1 st YEAR	B.SC	721135405069	M. Santhosh
68.	MYLAPALLI VENKATI	1 st YEAR	B.SC	721135405070	M. Venkati
69.	PANDURU HYMAVATHI	1 st YEAR	B.SC	721135405071	P. Hymanthi
70.	PILLA RAJA NARENDRA	1 st YEAR	B.SC	721135405072	P. Raja Narendra
71.	P. D.DHANALAXMI	1 st YEAR	B.SC	721135405073	P. D. Dhana Lakshmi
72.	ROUTHU NEERAJA	1 st YEAR	B.SC	721135405074	P. D. Dhana Lakshmi
73.	S. V. BHAVANI	1 st YEAR	B.SC	721135405075	S. V. Bhavani
74.	SIGIREDDY SANDHYA VENI	1 st YEAR	B.SC	721135405076	S. Sandhya Veni
75.	U. VENKATA SANTHOSH	1 st YEAR	B.SC	721135405077	U. Venkatasanthosh
76.	V. PRABHAKAR	1 st YEAR	B.SC	721135405078	V. Prabhakar
77.	VIYYAPU LOVARAJU	1 st YEAR	B.SC	721135405079	V. Lovaraju
78.	Y. DURGA PRASAD	1 st YEAR	B.SC	721135405080	Y. Durgaprasad

D. Sai Charan

Principal
S.G.A. Govt. Degree College
Yellamanchili - 531 035
Visakhapatnam District.

P. Chandra Babu

Principal
S.G.A. Govt. Degree College
YELLAMANCHILI - 531 035
Visakhapatnam District.

	MADHU VANI																	M. Vani
67	MUTYALA SANTHOSH	1 st YEAR	P	P	P	P	P	P	P	P	P	P	P	P	P	P	P	m. santhosh
68	MYLAPALLI VENKATI	1 st YEAR	P	P	P	P	P	P	P	P	P	P	P	P	P	P	P	M. Venkati
69	PANDURU HYMAVATHI	1 st YEAR	P	P	P	P	P	P	P	P	P	P	P	P	P	P	P	P. Hymavathi
70	PILLA RAJA NARENDRA	1 st YEAR	P	P	P	P	P	P	P	P	P	P	P	P	P	P	P	P. Narendra
71	P. D. DHANALAXMI	1 st YEAR	P	P	P	P	P	P	P	P	P	P	P	P	P	P	P	P. D. Dhana Lakshmi
72	ROUTHU NEERAJA	1 st YEAR	P	P	P	P	P	P	P	P	P	P	P	P	P	P	P	R. Neeraja
73	S. V. BHAVANI	1 st YEAR	P	P	P	P	P	P	P	P	P	P	P	P	P	P	P	S. V. Bhavani
74	SIGIREDDY SANDHYA VENI	1 st YEAR	P	P	P	P	P	P	P	P	P	P	P	P	P	P	P	S. Sandhya Veni
75	U. VENKATA SANTHOSH	1 st YEAR	P	P	P	P	P	P	P	P	P	P	P	P	P	P	P	U. V. Santhosh
76	V. PRABHAKAR	1 st YEAR	P	P	P	P	P	P	P	P	P	P	P	P	P	P	P	V. Prabhakar
77	VIYYAPU LOVARAJU	1 st YEAR	P	P	P	P	P	P	P	P	P	P	P	P	P	P	P	V. Lovaraju
78	Y. DURGA PRASAD	1 st YEAR	P	P	P	P	P	P	P	P	P	P	P	P	P	P	P	Y. Durgaprasad

D. Sai Charan

Principal

P. Chandrababu

Principal
S.G.A. Govt. Degree College
YELLAMANCHILI - 531 035
Vishakhapatnam District.

SGA GOVT. DEGREE COLLEGE, YELLAMANCHILI

DEPARTMENT OF COMPUTER SCIENCE

ADD-ON COURSE in WEB DESIGNING

QUESTION PAPER

TIME : 1 hour

Max Marks : 30

Answer all the following questions

3 x 10 = 30 M

- 1. Explain how to design a web page ?**
- 2. Explain how to design style sheets using DHTML ?**
- 3. Explain security and encryption ?**

D. Sai Charan

*2011-12 S. G. A. Govt. Degree College
Yellamanchili*

P. Chidambaram

Principal
S.G.A. Govt. Degree College
YELLAMANCHILI - 531 015
Vishakhapatnam District.



S.G.A.GOVERNMENT DEGREE COLLEGE

(Re-accredited by NAAC with 'A' Grade, Affiliated to Andhra University)

YELLAMANCHILI - 531055, ANDHRA PRADESH



DEPARTMENT OF COMPUTER SCIENCE

Add -on Course in **WEB DESIGNING** for the academic year 2021-22

SUMMARY REPORT

The department of **Computer Science** has started add - on course on "**web designing**" with 78 students from all final years of sga gdc.

Department of **computer science** conducted 30 classes to complete the syllabus within stipulated time from 14/02/2022 to 03 /03 /20 22. The exams were conducted to registered students for 30 marks and issued certificates to all students.

Web designing is one of the important employment field in present era. There are many opportunities to students in social media and web designing . So department of **computer science** introduced this course for the benefit of students in their future .all the students were presented and gained proper knowledge in **web designing** .

- 1 . Number of students enrolled : 78
2. Number of students completed : 78
3. Classes conducted :30 hours
4. Maximum marks : 30 marks
5. Time : morning and evening 2 hours.

D. Sai charan

Head of Computer Science

P. Chandra Babu

Principal
S.G.A.Govt.Degree College
YELLAMANCHILI - 531 055
Visakhapatnam District.



S.G.A.GOVERNMENT DEGREE COLLEGE

(Re-accredited by N.A.A.E. with 'A' Grade, Affiliated to Andhra University)

VELLAMANCHILI - 534085, ANDHRA PRADESH



DEPARTMENT OF COMPUTER SCIENCE

ADD-ON COURSE IN

"WEB DESIGNING"

CERTIFICATE

This is to certify that Mr./Ku _____ S/o/D/o _____

Regd. No _____ has successfully completed the add-on course in

"WEB DESIGNING" in this college held from _____ to _____.

Head of the Department

The Principal



SRI GURAJADA APPA RAO GOVERNMENT DEGREE COLLEGE



NAAC A GRADE

Annexure -A

We here by confirm that APSSDC sponsored training on Pharma marketing executive Offline classes have been organized to our ESC registered students in our campus, the details of the programme are:

Subject/Course	Pharma marketing executive					
Name of the trainer	Prasanth					
Training Start Date	10-01-2020					
Training Completion Date	09-03-2020					
Duration (hrs)	60 hrs					
Students attended (Course and Year wise) (Enclose attendance sheet of the programme)	Course	Group	Students attended			
			1 st year	2 nd year	3 rd year	Total
	B.sc	MPC , CBZ			59	59
Feed Back about trainer (Excellent/Good/Average/ Bad)	Excellent					
Feedback about programme	Excellent					
Suggestions / Remarks						

SPOC Signature:

10/3/2020

SPOC Name:

M. Vidya Kalpana

Date:

Principal Signature

10. 3. 2020

Principal Name

Dr. K. MALYADRI, M.Com, Ph.D.

PRINCIPAL

SGA GOVT. DEGREE COLLEGE

Yellamanchili, Visakhapatnam Dt. (A.P)-531055

ANNEXURE-B

Feedback Analysis of Participant- Summary

College Name: S.G.A Government Degree College.

District: Visakhapatnam

Date: From 10/01/2020 To 09/03/2020

Total No of participants: 52

1) Training delivery of Trainer

Parameter	Excellent	Very good	Good	Satisfactory	Poor	Total
No. of candidates	30	10	12			52

2) Duration of the training programme ?

Parameter	Short	Adequate	Long	Total
No. Of candidates	40	12		52

3) Did you find the programme useful?

Parameter	Very much	To some extent	Not useful	Total
No. Of candidates	52			52

4) Is it upto your expectations?

Parameter	Yes	To some extent	No	Total
No. of candidates	52			52

5) Planning of the programme

Parameter	Excellent	Very good	Good	Satisfactory	Poor	Total
No. of candidates		32	20			52

6) Major suggestions/ comments of trainees:

- 1) We are so happy for this class, Requesting you to conduct more classes like pharma marketing.

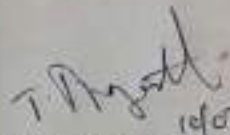
Trainer signature: 10/03/2020

Name :

Date:

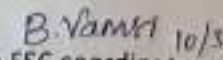
Signature ESC coordinator: 10/3/2020

Name: B. VAHSI

Date:

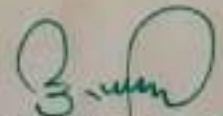
Principal signature: 10-3-2020

Name:

Date: Dr. K. MALYADRI, M.Com, Ph.D.

PRINCIPAL
SGA GOVT. DEGREE COLLEGE
Yellamanchili, Visakhapatnam Dt. (A.P.)-531055

ANNEXURE-C**List of Candidates and attendance details**

College Name : S.G.A Government Degree College.

District: Visakhapatnam

Course Name: Pharma Marketing Executive.

Test Date: 09-03-2020 .

Total Training hours:60hrs

S.No.	Student name	Course	Group	Online/Offline test Taken(Yes/ No)	Remarks
1	S.Neerjana mani	B.Sc	C.B.Z	Yes	Excellent
2	N.Rama devi	B.Sc	C.B.Z	Yes	Good
3	N.Jaya lakshmi	B.Sc	C.B.Z	Yes	Excellent
4	V.Krupa Rani	B.Sc	C.B.Z	Yes	Good
5	N.Triveni	B.Sc	C.B.Z	Yes	Excellent
6	D.Sudha laxmi	B.Sc	C.B.Z	Yes	Good
7	R.Satyaveni	B.Sc	C.B.Z	Yes	Excellent
8	B.Latha	B.Sc	C.B.Z	Yes	Good
9	J.Bhavni	B.Sc	C.B.Z	Yes	Excellent
10	K.Chandrika	B.Sc	C.B.Z	Yes	Excellent
11	R.Ramesh	B.Sc	C.B.Z	Yes	Excellent
12	T.Sarla Sanya	B.Sc	C.B.Z	Yes	Good
13	M.Durga	B.Sc	C.B.Z	Yes	Excellent
14	K.Rani	B.Sc	C.B.Z	Yes	Excellent
15	D.Sai Ramya	B.Sc	C.B.Z	Yes	Excellent
16	G.Madhavi	B.Sc	C.B.Z	Yes	Good
17	V.Annapoorna	B.Sc	C.B.Z	Yes	Excellent
18	G.Naga mani	B.Sc	C.B.Z	Yes	Good
19	B.Revathi	B.Sc	C.B.Z	Yes	Excellent
20	L.Lavanya	B.Sc	C.B.Z	Yes	Excellent
21	CH.Sravani	B.Sc	C.B.Z	Yes	Excellent
22	K.Rama devi	B.Sc	C.B.Z	Yes	Good
23	I.Baby	B.Sc	C.B.Z	Yes	Excellent
24	A.Umakantham	B.Sc	C.B.Z	Yes	Excellent
25	G.Bhavani	B.Sc	C.B.Z	Yes	Excellent
26	D.chandrakala	B.Sc	C.B.Z	Yes	Good
27	B.Gayatri	B.Sc	C.B.Z	Yes	Excellent
28	P.Naga Lakshmi	B.Sc	C.B.Z	Yes	Good
29	CH.Kodanada	B.Sc	C.B.Z	Yes	Excellent
30	Y.Devi	B.Sc	C.B.Z	Yes	Excellent
31	A.mounika rani	B.Sc	M.P.C	Yes	Excellent
32	P.Tulasi	B.Sc	M.P.C	Yes	Good
33	P.Rajesh	B.Sc	M.P.C	Yes	Excellent
34	G.Tata rao	B.Sc	M.P.C	Yes	Good
35	A.Jhansy	B.Sc	M.P.C	Yes	Excellent
36	D.Babuji	B.Sc	M.P.C	Yes	Good
37	Sk.Noorjahan	B.Sc	M.P.C	Yes	Excellent
38	Y.Kumari	B.Sc	M.P.C	Yes	Excellent

39	K.Anusha	B.Sc	M.P.C	Yes	Excellent
40	T.Ganga Raju	B.Sc	M.P.C	Yes	Good
41	P.Durga Prasad	B.Sc	M.P.C	Yes	Excellent
42	K.Roja Rani	B.Sc	M.P.C	Yes	Good
43	R.satyanarayana	B.Sc	M.P.C	Yes	Excellent
44	K.Thataji	B.Sc	M.P.C	Yes	Excellent
45	D.Babuji	B.Sc	M.P.C	Yes	Excellent
46	D.Bharathi	B.Sc	M.P.C	Yes	Good
47	A.Sweetha	B.Sc	M.P.C	Yes	Excellent
48	K.Chaturya	B.Sc	M.P.C	Yes	Good
49	D.malathi chinnari	B.Sc	M.P.C	Yes	Excellent
50	J.Sai Durga	B.Sc	M.P.C	Yes	Excellent
51	B.Glory sunitha	B.Sc	M.P.C	Yes	Excellent
52	P.Manga	B.Sc	M.P.C	Yes	Good

Consolidated information:

Course	Group	No. of students trained	No of students taken online/Offline test	No. of students absent	Students secured above 36%
B.sc	MPC, CBZ	59	52	7	100%

DSDO Signature:

DSDO Name:

Date:

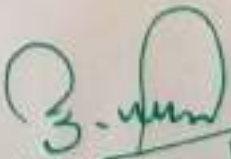
Principal Signature  10.3.2020

Principal Name
Dr. R. MALYADRI, M.Com, Ph.D.
PRINCIPAL

Date: SGA GOVT. DEGREE COLLEGE
Yellamanchili, Visakhapatnam Dt. (A.P)-531055









SGA Govt. Degree College, Yellamanchili

Department of Botany

ICT Class for III CBZ, 2021-22



Name: Dr. B. Chandramouli Topic: *Alstonia scholaris* Date: 07-02-2022



Name: Dr. B. Chandramouli Topic: *Zingiber officinale* Date: 07-02-2022

SGA Govt. Degree College, Yellamanchili
Department of Botany
ICT Classes for 2021-22



Name: Smt. V. Padmaja Topic: Endosperm culture Date: 08-02-2022



Smt V. Padmaja, Lecturer in Botany Explaining the culture of Endosperm



SRI GURAJADA APPA RAO GOVERNMENT DEGREE COLLEGE



Vijilankuntla - 531055, ANDHRA PRADESH

Department of Botany

ICT Class for I CBZ (SEM-II), 2021-22

Topic: Anomalous secondary growth in Boerhavia stem

Resource person: Dr. B. Chandramouli

Date: 18-02-2022



Dr. B. Chandramouli, Lecturer in Botany Explaining the Boerhavia stem T.S



SRI GURAJADA APPARAO GOVERNMENT DEGREE COLLEGE

(Re-accredited by NAAC with 'A' Grade, Affiliated to Andhra University)

VELLAMANCHILI- 531055, ANDHRA PRADESH



DEPARTMENT OF PHYSICS

ICT CLASSES (2016-2021)

S.NO	DATE	NAME OF THE LECTURER	GROUP	NAME OF THE TOPIC
1.	23-11-2017	Sri B. Nageswara Rao, Lecturer in physics	MPC, MPCs	Logic Gates
2.	09-08-2018	Sri B. Nageswara Rao, Lecturer in physics	MPC, MPCs	Kepler Laws
3.	10-07-2019	Sri B. Nageswara Rao, Lecturer in physics	MPC, MPCs	Hydrogen Spectrum
4.	27-10-2021	Sri K. Venkanna, Lecturer in physics	MPC, MPCs	Various opportunities in scientific institutes and their present role in nation's development
5.	26-11-2021	Sri P S Jaggarao, Lecturer in physics	MPC, MPCs	Renewable energies
6.	03-12-2021	Sri P S Jaggarao, Lecturer in physics	MPC, MPCs	Opportunities in physics
7.	07-12-2021	Sri P S Jaggarao, Lecturer in physics	MPC, MPCs	Solar energy

In-charge of the department

Head of the Department
Department of Physics
S.G.A. Govt. Degree College
Yellamanchili-531055
ANAKAPALLI District



Principal

Principal
S.G.A. Govt. Degree College

Yellamanchili-531055
ANAKAPALLI District



SRI GURAJADA APPARAO GOVERNMENT DEGREE COLLEGE

(Re-accredited by NAAC with 'A' Grade, Affiliated to Andhra University)

VELLAMANCHILI - 531055, ANDHRA PRADESH



DEPARTMENT OF PHYSICS



**ICT class conducted to III B.Sc students on "Logic Gates" by Sri
B.Nageswara Rao, Lect. in Physics dated 23.11.2017**

Principal

S.G.A. Govt. Degree College
Yellamanchili-531 055
Anakapalli District. (A.P)

Signature of the HOD
Head of the Department
Department of Physics
S.G.A. Govt. Degree College
Yellamanchili-531055
ANAKAPALLI District



SRI GURAJADA APPARAO GOVERNMENT DEGREE COLLEGE
(Re-accredited by NAAC with 'A' Grade, Affiliated to Andhra University)
YELLAMANCHILI - 531055, ANDHRA PRADESH



DEPARTMENT OF PHYSICS



ICT class conducted to 1 B.Sc students on " Kepler Laws" by Sri B.Nageswara Rao, Lect. in Physics dated 09.08.2018

Principal

S.G.A. Govt. Degree College
Yellamanchili- 531 055
Anakapalli District, (A.P)

Signature of the HOD
Head of the Department
Department of Physics
S.G.A. Govt. Degree College
Yellamanchili-531055
ANAKAPALLI District



SRI GURAJADA APPARAO GOVERNMENT DEGREE COLLEGE

(Re-accredited by NAAC with 'A' Grade, Affiliated to Andhra University)

VELLAMANCHILI - 531055, ANDHRA PRADESH



DEPARTMENT OF PHYSICS



**ICT Class conducted to I B.Sc students on " Hydrogen Spectrum"
dated 10.07.2019**

Principal

S.G.A. Govt. Degree College
Yellamanchili-531 055
Anakapalli District. (A.P)

Signature of the HOD
Head of the Department
Department - Physics
S.G.A. Govt. Degree College
Yellamanchili-531055
ANAKAPALLI District



ICT class on **"VARIOUS OPPURTUNITIES IN SCIENTIFIC INSTITUTES AND THEIR PRESENT ROLE IN NATION'S DEVELOPMENT"** to I-B.Sc Students dated: 27-10-2021.

Signature of HOD
Head of the Department
Department of Physics
S.G.A. Govt. Degree College
Yellamanchili-531055
ANAKAPALLI District

Signature of the Principal
Principal
S.G.A. Govt. Degree College
YELLAMANCHILI - 531 055
Visakhapatnam District.



SRI GURAJADA APPARAO GOVERNMENT DEGREE COLLEGE



Yellamanchili - 531055, ANDHRA PRADESH



ICT CLASS CONDUCTED TO III-B.Sc ON "RENEWABLE ENERGIES" BY SRI P S JAGGARAO, LECTURER IN PHYSICS DATED: 26-11-2021.

Signature of the HOD
Head of the Department
Department of Physics
S.G.A. Govt. Degree College
Yellamanchili-531055
ANAKAPALLE District

Signature of the principal

Principal
S.G.A. Govt. Degree College
YELLAMANCHILI - 531055
Visakhapatnam District.



SRI GURAJADA APPA RAO GOVERNMENT DEGREE COLLEGE



Yellamanchili - 531055, ANDHRA PRADESH



ICT CLASS CONDUCTED TO I-B Sc STUDENTS ON "OPPORTUNITIES IN PHYSICS"
BY SRI P S JAGGARAO, LECTURER IN PHYSICS DATED : 03-12-2021.

Signature of HOD

Head of the Department
Department of Physics
S.G.A. Govt. Degree College
Yellamanchili-531055
ANAKAPALLI District

Signature of the Principal

Principal
S.G.A. Govt. Degree College
YELLAMANCHILI - 531055
Veesithapuram District.



SRI GURAJADA APPA RAO GOVERNMENT DEGREE COLLEGE



Yellamanchili - 531055, ANDHRA PRADESH



ICT CLASS ON "**SOLAR ENERGY**" FOR III-B, Sc STUDENTS BY SRI P S JAGGA RAO,
LECTURER IN PHYSICS DATED: 07-12-2021.

Signature of Department Head
Head of the Department
Department of Physics
S.G.A. Govt. Degree College
Yellamanchili-531055
ANAKAPALLE District

Signature of Principal

Principal
S.G.A. Govt. Degree College
YELLAMANCHILI - 531 055
Vizianagaram District.



Vivo V11Pro
AI Dual Camera



Vivo V11Pro
AI Dual Camera





S.G.A.GOVERNMENT DEGREE COLLEGE

(Re-accredited by NAAC with 'A' Grade, Affiliated to Andhra University)

YELLAMANCHILI - 531055, ANDHRA PRADESH



DEPT.OF ECONOMICS

CERTIFICATE COURSE: 2021-22

M.S. WORD



S.G.A.GOVERNMENT DEGREE COLLEGE

(Re-accredited by NAAC with 'A' Grade, Affiliated to Andhra University)

YELLAMANCHILI - 531055, ANDHRA PRADESH



31-01-2022

DEPARTMENT OF ECONOMICS

DEPARTMENTAL MEETING

Minutes of meeting

The faculty of department of economics met on 31-01-2022 and discussed the following matters

- 1. Resolve to start an add-on course in the Department of economics**
- 2. To submit a letter to principal for getting the permission to start Certificate Course MS WORD**
- 3. To prepare syllabus to the Certificate Course**
- 4. To start the students with a minimum of 20 students.**
- 5. To conduct three weeks (21 days) teaching and practical hours.**
- 6. To conduct EXAM at end of the course and to issue course completion Certificates to successfully completed students.**
- 7. Permission to conduct the add on course by the economics faculty.**
- 8. Permission to utilize JKC Computers**



S.G.A.GOVERNMENT DEGREE COLLEGE

(Re-accredited by NAAC with 'A' Grade, Affiliated to Andhra University)

YELLAMANCHILI - 531055, ANDHRA PRADESH



PERMISSION LETTER TO START CERTIFICATE COURSE

FROM

Head of the Department,
Department Of Economics
SGA Govt. Degree College
Yellamanchill.

TO

The Principal,
S.G.A.Govt.Degree College,
Yellamanchili.

Sub: Permission to start Certificate course (short term course)- Regarding

REF: Resolution copy of the department of economics.

Respected sir,

As per the resolution of the department of economics we are very much interested to start Certificate course (short term course) with a title Microsoft office word for the B.A (HERI) students ,so we are requesting you to give permission to start that add on course and also permit us to act as the faculty for the add-on course.

Thanking you sir,



S.G.A.GOVERNMENT DEGREE COLLEGE

(Re-accredited by NAAC with 'A' Grade, Affiliated to Andhra University)

YELLAMANCHILI - 531055, ANDHRA PRADESH



DEPARTMENT OF ECONOMICS

SYLLABUS

Course Content:

M.S Windows, Computer Basics

Creating folders, Directories, Input units, Output unit, Central processing units what is hardware and Software, Windows short cut keys

Module 1: Text Basics

Typing the text, Alignment of text, Editing Text: Cut, Copy, Paste, Select All, Clear, Find & Replace

Module 2: Text Formatting and saving file:

New, Open, Close, Save, Save As, Formatting Text: Font Size, Font Style Font Color, Use the Bold, Italic, and Underline, Change the Text Case, Line spacing, Paragraph spacing, Shading text and paragraph.

Module 3: Working with Objects:

Shapes, Clipart and Picture, Word Art, Smart Art, Columns and Orderings - To Add Columns to a Document, Change the Order of Objects, Page Number, Date & Time, Inserting Text boxes, Inserting Word art, Inserting symbols, Inserting Chart

Module 4: Header & Footers:

Inserting custom Header and Footer, Inserting objects in the header and footer, Add section break to a document.



Module 5: Working with bullets and numbered lists:

Multilevel numbering and Bulleting, Creating List, Customizing List style, Pagebordering, Page background.

Module 6: Tables:

Working with Tables, Table Formatting, TableStyles, Alignment option Merge and split option.

Module 7: Styles and Content:

Using Build- in Styles, Modifying Styles , Creating Styles, Creating a list style ,Table of contents and references ,Adding internal references ,Adding a Footnote ,Adding Endnote

Module 8: Merging Documents:

Typing new address list , Importing address list from Excel file , Write and insert field ,Merging with outlook contact ,Preview Result , Merging to envelopes ,Merging to label ,Setting rules for merges ,Finish & Merge options

Module 9: Sharing and Maintaining Document:

Changing Word Options, Changing the Proofing Tools, ManagingTemplates, Restricting Document Access, Using Protected View, Working with Templates, ManagingTemplates, Understanding building blocks

Module 10: Proofing the Document:

Check Spelling As You Type. , Mark Grammar Errors as You Type, Setting AutoCorrect Options

Module 11: Printing:

Page Setup, Setting margins, Print Preview, Print



S.G.A.GOVERNMENT DEGREE COLLEGE

(Re-accredited by NAAC with 'A' Grade, Affiliated to Andhra University)

YELLAMANCHILI - 531055, ANDHRA PRADESH



MS-OFFICE word

ASHORT TERM CERTIFICATE COURSE

CLASS ATTENDANCE-II B.A

FEBRUARY-2022

S.NO	NAME OF THE STUDENT	REG.NO	1	2	3	4	5	7	8	9	10	11	14	15	16	17	18	19	21	22	23	24	25	Signatur of the Student	
1	A.KONDA BABU	120135401001	P	P	P	P	P	P	P	P	A	P	P	P	A	P	P	P	P	P	P	P	P		
2	B .GOWRI DEVI	120135401002	A	P	P	P	A	A	A	A	A	A	A	P	P	P	P	A	A	A	A	A	A	A	
3	CH.HARSHAVARDHAN	120135401003	P	P	P	A	P	A	P	P	A	P	P	A	A	A	A	P	P	P	P	A	A		
4	D.A.V.V.S.N.MURTHY	120135401004	P	A	A	P	A	P	P	A	A	A	A	A	P	P	P	P	A	A	P	P	A		
5	D.PAVANKUMARI	120135401005	P	P	A	A	P	P	P	P	P	P	A	P	P	P	A	P	P	P	P	P	P		
6	E.SARASWATHI	120135401007	P	P	P	P	P	P	P	P	P	P	P	P	P	P	P	A	P	P	P	P	P		
7	K.SRINUVASURAO	120135401008	P	A	A	P	P	P	A	A	A	A	A	A	A	P	P	P	P	A	P	A	P		
8	K.MOHAN	120135401009	P	P	A	A	A	A	A	A	A	A	A	A	A	A	A	P	P	A	A	A	A	A	
9	K.DURGA PRASAD	120135401011	P	P	A	P	P	P	P	P	P	A	A	P	P	P	P	P	P	P	A	P	P		
10	K.APPALARAJU	120135401013	P	P	A	A	A	P	A	P	P	P	A	A	P	A	P	P	P	A	A	A	P		
11	P.MUNNA	120135401015	P	P	A	P	P	P	A	P	A	A	A	P	P	P	A	A	P	A	P	P	A		
12	P DURGAPRASAD	120135401016	P	P	A	A	A	A	A	P	P	A	P	A	P	A	P	P	P	A	A	A	P		
13	R.VENKATA LAKSHMI	120135401017	P	P	P	P	P	P	P	P	P	P	P	P	A	P	P	P	P	A	P	P	P		
14	R.GANESH	120135401018	P	P	A	A	P	A	P	A	P	P	P	P	A	P	P	A	P	P	P	P	P		
15	R. B.APARNA	120135401019	P	P	P	P	P	P	P	P	P	P	P	P	A	P	P	P	P	P	P	P	P		
16	S. DHANA LAKSHMI	120135401020	P	P	P	P	A	P	P	P	P	P	P	A	A	P	A	P	P	P	P	P	P		
17	Y RAMATEJA	120135401021	P	P	A	P	P	P	P	P	A	P	P	P	P	A	A	A	P	P	P	P	P		
18	B.TEJA RUPINI	121135401007	P	P	P	P	P	A	A	P	P	P	P	P	A	P	P	P	P	A	P	P	P		
19	G.NOOKARATNAM	121135401010	P	P	P	P	P	P	P	P	P	A	P	P	P	P	P	P	P	P	P	P	P		
20	P.VINAYA KUMAR	121135401015	P	P	P	P	P	P	P	P	P	P	A	P	A	P	P	P	P	P	P	P	P		
21	Y.SAI DURGA	121135401021	P	P	P	P	P	A		P	A	P	P	P	P	A	P	P	P	A	P	P	P		

Signature of the Coordinator

Signature of the Principal



Final exam paper

Certificate course

Department of Economics 25 MARKS

1)MS word is software of ____

- (A) Apple (B) Android
(C) Google (D) Microsoft

2)The valid format of MS Word is ____

- (A) .exe (C) .png
(B) .doc (D) .jpeg

3)"Www" stands for:

- (A) World Wide Web (C) World Wide Wait
(B) World Wide Wares (D) World Wide War

4)What does CPU stand for?

- (A) Cute People United (C) Computer Parts of USA
(B) Commonwealth Press Union (D) Central Processing Unit

5)Which is not an Internet protocol?

- (A) HTTP (C) STP
B) FTP(D) IP

6)TXT' extension refers usually to what kind of file?

- (A) Text File (C) Audio file
(B) Image file (D) Adobe Acrobat files



7)What's a web browser?

(A) A kind of spider (C) A person who likes to look at websites(B) A computer that stores WWW files(D) A software program that allows you to access sites on the World Wide Web

8)Which of the following to justification align the text on both the sides-left and right of margin?

(A) Balanced (C) Justify

(B) Right (D) Balanced

9)Line spacing is in the ____ of MS Word.

(A) Format tab (C) Insert tab

(B) View tab(D) Home tab

10)____ button reduces the window to an icon but word still remains active.

(A) Close(C) Maximize

(B) Restore

(D) Minimize

11) What is the smallest width of a column?

(A) 0"

(C) 0.5"

(B) 1"

(D) 1.5"

12)Arial, Cambria, Verdana, Times New Roman are the name of ____

(A) Highlights (C) Text

(B) Font face (D) Alignment

13)To make the selected text bold, the shortcut key is ____

(A) Alt+ B (C) Ctrl+ B

(B) Shift+ B(D) Space +H



14) Which of the following is not an option in clipboard?

- (A) Cut (C) Paste
- (B) Copy (D) Page setup

15) Changing the appearance of a document is called as ____

- (A) Page orientation (C) Finding
- (B) Editing (D) Formatting

16) Zoom in and out button is available on

- (A) Scroll bar (C) Page layout tab
- (B) Home tab (D) View option toolbar

17) What is the blinking symbol on the screen that shows where the next character will appear?

- (A) Cursor (C) Arrow key
- (B) Delete key (D) Return key

18) What is a note or annotation that an author or reviewer adds to a document?

- (A) Comment (C) Header
- (B) Caption (D) Footer

19) The document can be zoomed maximum up to

- (A) 150% (C) 400%
- (B) 200% (D) 500%

20) ____ refers to back the object to one level or to all objects.

- (A) Align (C) Bring to front
- (B) Rotate (D) Send to back

21) ____ refers to a title for a part of a document.



(A) Leader characters (C) Header

(B) Indent(D) Heading

22)What is the ghosted text or picture behind the content on the page?

(A) Clipart(C) WordArt

(B) Watermark (D) All of these

23)In MS word we insert

(A) Page number(C) Table

(B) Text Box(D) All of these

24)Which is not a page size in MS Word document?

(A) A3

(C) Letter

(B) A4

(D) Z100

25) User can use _____ commands to search for and correct words in a document.

(A) Copy and Paste

(C) Header and Footer

(B) Find and Replace

(D) Print and Print preview

ADD-ON COURSE: M.S OFFICE WORD ANSWER KEY

1).D 2).B 3).A 4).D 5).C 6)A 7).D 8)C 9).D 10).D 11).C

12)B 13)C 14).D 15).D 16).D 17).A 18).A 19).D 20)D

21)D 22).B 23).D 24).D 25).B



S.G.A.GOVERNMENT DEGREE COLLEGE

(Re-accredited by NAAC with 'A' Grade, Affiliated to Andhra University)

YELLAMANCHILI - 531055, ANDHRA PRADESH



S.G.A. GOVERNMENT DEGREE COLLEGE

(Affiliated to Andhra University)

Accredited By NAAC with "A" Grade

Yellamanchili Visakhapatnam Andhra Pradesh



COURSE COMPLETION CERTIFICATE

This certificate is awarded to Sri/Kum_____ of I and II B.A (HERI) on completion of Certificate Course in "MS-WORD", organised by Department of Economics for the Academic year 2021-22.

Course co-ordinator
HOD, Department of Chemistry

Course resource person

Principal



S.G.A.GOVERNMENT DEGREE COLLEGE

(Re-accredited by NAAC with 'A' Grade, Affiliated to Andhra University)

YELLAMANCHILI - 531055, ANDHRA PRADESH



DEPARTMENT OF ECONOMICS

Certificate Course' for the academic year 2021-22

SUMMARY REPORT

The department of Economics has started **Certificate Course on 'MS WORD'** with 21 students from **B.A.** second years of SGA GDC. Department of Economics conducted 21 classes to complete the syllabus within stipulated time from 01-02-2022 to 25-02-2022. The exams were conducted to registered students for 25 marks and issued certificates to all students.

Mutual Funds Subject is one of the important employment fields in present era. There are ample opportunities for students in MS office in the job market. So Department of Economics introduced this course for the benefit of students in their future. All the students were presented and gained practical knowledge in MS WORD.

1. Number of students enrolled: 21
2. Number of students completed: 21
3. Classes conducted : 21 hours
4. Maximum marks: 25 marks
5. Time: morning and evening 1 hour.

Course Co - Ordinator

Principal



S.G.A. GOVERNMENT DEGREE COLLEGE

(Re-accredited by NAAC with 'A' Grade, Affiliated to Andhra University)

YELLAMANCHILI - 531055, ANDHRA PRADESH



S.G.A. GOVERNMENT DEGREE COLLEGE

(Affiliated to Andhra University)

Accredited By NAAC with "A" Grade

Yellamanchili Visakhapatnam Andhra Pradesh



COURSE COMPLETION CERTIFICATE

This certificate is awarded to Sri/Kum _____
of I and II B.A (HERI) on completion of Certificate Course in "MS-WORD",
organised by Department of Economics for the Academic year 2021-22.

Course co-ordinator
HOD, Department of Chemistry

Course resource person

Principal